

GeoMax Zipp10 Pro Series User Manual



Version 1.1

Introduction

Purchase

Congratulations on the purchase of a GeoMax Zipp10 Pro series instrument.



This manual contains important safety directions as well as instructions for setting up the product and operating it. Refer to "1 Safety Directions" for further information. Read carefully through the User Manual before you switch on the product.

Product identification

The type and serial number of your product are indicated on the type plate. Enter the type and serial number in your manual and always refer to this information when you need to contact your agency or GeoMax authorised service workshop.

Type: _____

Serial No.: _____

Trademarks

- Windows is a registered trademark of Microsoft Corporation in the United States and other countries. All other trademarks are the property of their respective owners.

Validity of this manual

	Description
General	This manual applies to Zipp10 Pro instruments. Where there are differences between the models they are clearly described.
Telescope	<ul style="list-style-type: none">• Measuring with P modes: When measuring distances to a reflector with Electronic Distance Measurement (EDM) mode "P", the telescope uses a wide visible red laser beam, which emerges coaxially from the telescope's objective.• Measuring with NP modes: Instruments that are equipped with a reflectorless EDM additionally offer the EDM mode "NP". When measuring distances with this EDM mode, the telescope uses a narrow visible red laser beam, which emerges coaxially from the telescope's objective.

WARNING

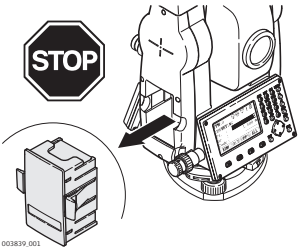

Do **NOT** remove the battery during operation of the instrument, or during the shutdown procedure. This can result in a file system error and data loss!

Always switch off the instrument by pressing the On/Off key, and wait until the instrument has shutdown completely before removing the battery.

Table of Contents

In this manual	Chapter	Page
1	Safety Directions	5
1.1	General	5
1.2	Definition of Use	5
1.3	Limits of Use	6
1.4	Responsibilities	6
1.5	Hazards of Use	6
1.6	Laser Classification	8
1.6.1	General	8
1.6.2	Distancer, Measurements with Reflectors	8
1.6.3	Distancer, Measurements without Reflectors (NP mode)	9
1.6.4	Laser Plummet	10
1.7	Electromagnetic Compatibility EMC	11
1.8	FCC Statement, Applicable in U.S.	12
2	Description of the System	13
2.1	System Components	13
2.2	Container Contents	13
2.3	Instrument Components	14
3	User Interface	15
3.1	Keyboard	15
3.2	Screen	15
3.3	Status Icons	16
3.4	Softkeys	16
3.5	Operating Principles	17
3.6	Pointsearch	17
4	Operation	18
4.1	Instrument Setup	18
4.2	Working with the Battery	20
4.3	Data Storage	20
4.4	Main Menu	21
4.5	Quick-Survey Application	21
4.6	Distance Measurements - Guidelines for Correct Results	22
5	Settings	23
5.1	General Settings	23
5.2	EDM Settings	25
5.3	System Information	26
6	Loading Software	27
7	Functions	28
7.1	Overview	28
7.2	Angle Offset	28
7.3	Distance Offset	29
7.4	Repeated Angle Measurement	30
8	Coding	31
9	Applications - Getting Started	32
9.1	Overview	32
9.2	Starting an Application	32
9.3	Selecting the Job	33
9.4	Selecting the Station	34
9.5	Selecting the Orientation	35
9.5.1	Overview	35
9.5.2	Manual Orientation	35
9.5.3	Orientation with Coordinates	35

10	Application	36
10.1	Common Fields	36
10.2	Data Collect	36
10.3	Missing Line Measurement	37
10.4	Resection	38
	10.4.1 Starting Resection	38
	10.4.2 Measuring Information	39
	10.4.3 Computation Procedure	39
	10.4.4 Resection Results	40
10.5	Set Out	41
10.6	Area & Volume	43
10.7	Remote Elevation	44
10.8	Road Stakeout	45
11	Data Management	49
11.1	Data Manager	49
11.2	Data Transfer	50
	11.2.1 Exporting Data	50
	11.2.2 Importing Data	51
11.3	Working with a USB Memory Stick	52
11.4	Working with GeoMax Office	52
12	Calibration	53
12.1	Overview	53
12.2	Preparation	53
12.3	Calibrating Line-of-Sight and Vertical Index Error	54
12.4	Calibrating the Level of the Instrument and Tribrach	56
12.5	Inspecting the Laser Plummet of the Instrument	56
12.6	Servicing the Tripod	57
13	Care and Transport	58
13.1	Transport	58
13.2	Storage	58
13.3	Cleaning and Drying	58
14	Technical Data	59
14.1	Angle Measurement	59
14.2	Distance Measurement with Reflectors	59
14.3	Distance Measurements without Reflectors (Reflectorless mode)	60
14.4	Conformity to National Regulations	61
	14.4.1 Zipp10 Pro	61
14.5	General Technical Data of the Instrument	61
14.6	Scale Correction	63
14.7	Reduction Formulas	64
15	Glossary	65
Appendix A	Menu Tree	67
Appendix B	Directory Structure	68

1 Safety Directions

1.1 General

Description The following directions enable the person responsible for the product, and the person who actually uses the equipment, to anticipate and avoid operational hazards. The person responsible for the product must ensure that all users understand these directions and adhere to them.





About Warning Messages Warning messages are an essential part of the safety concept of the instrument. They appear wherever hazards or hazardous situations can occur.

Warning messages...

- make the user alert about direct and indirect hazards concerning the use of the product.
- contain general rules of behaviour.

For the users' safety, all safety instructions and safety messages shall be strictly observed and followed! Therefore, the manual must always be available to all persons performing any tasks described herein.

DANGER, WARNING, CAUTION and NOTICE are standardized signal words for identifying levels of hazards and risks related to personal injury and property damage. For your safety it is important to read and fully understand the table below with the different signal words and their definitions! Supplementary safety information symbols may be placed within a warning message as well as supplementary text.

Type	Description
 DANGER	Indicates an imminently hazardous situation which, if not avoided, will result in death or serious injury.
 WARNING	Indicates a potentially hazardous situation or an unintended use which, if not avoided, could result in death or serious injury.
 CAUTION	Indicates a potentially hazardous situation or an unintended use which, if not avoided, may result in minor or moderate injury.
NOTICE	Indicates a potentially hazardous situation or an unintended use which, if not avoided, may result in appreciable material, financial and environmental damage.
	Important paragraphs which must be adhered to in practice as they enable the product to be used in a technically correct and efficient manner.

1.2 Definition of Use

- Intended use**
- Measuring horizontal and vertical angles.
 - Measuring distances.
 - Recording measurements.
 - Visualizing the aiming direction and vertical axis.
 - Data communication with external appliances.
 - Computing by means of software.

- Reasonably foreseeable misuse**
- Use of the product without instruction.
 - Use outside of the intended use and limits.
 - Disabling safety systems.
 - Removal of hazard notices.
 - Opening the product using tools, for example screwdriver, unless this is specifically permitted for certain functions.
 - Modification or conversion of the product.
 - Use after misappropriation.
 - Use of products with obviously recognisable damages or defects.
 - Use with accessories from other manufacturers without the prior explicit approval of GeoMax.
 - Aiming directly into the sun.
 - Inadequate safeguards at the working site.
 - Deliberate dazzling of third parties.
 - Controlling of machines, moving objects or similar monitoring application without additional control- and safety installations.

1.3 Limits of Use

Environment Suitable for use in an atmosphere appropriate for permanent human habitation: not suitable for use in aggressive or explosive environments.

 **DANGER** Local safety authorities and safety experts must be contacted before working in hazardous areas, or close to electrical installations or similar situations by the person in charge of the product.

1.4 Responsibilities

Manufacturer of the product GeoMax AG, CH-9443 Widnau, hereinafter referred to as GeoMax, is responsible for supplying the product, including the user manual and original accessories, in a safe condition.

Person responsible for the product The person responsible for the product has the following duties:

- To understand the safety instructions on the product and the instructions in the user manual.
- To ensure that it is used in accordance with the instructions.
- To be familiar with local regulations relating to safety and accident prevention.
- To inform GeoMax immediately if the product and the application becomes unsafe.
- To ensure that the national laws, regulations and conditions for the operation of e.g. radio transmitters or lasers are respected.

1.5 Hazards of Use

 **CAUTION** Watch out for erroneous measurement results if the product has been dropped or has been misused, modified, stored for long periods or transported.

Precautions: Periodically carry out test measurements and perform the field adjustments indicated in the user manual, particularly after the product has been subjected to abnormal use and before and after important measurements.

 **DANGER** Because of the risk of electrocution, it is dangerous to use poles and extensions in the vicinity of electrical installations such as power cables or electrical railways.

Precautions: Keep at a safe distance from electrical installations. If it is essential to work in this environment, first contact the safety authorities responsible for the electrical installations and follow their instructions.



 **CAUTION** Be careful when pointing the product towards the sun, because the telescope functions as a magnifying glass and can injure your eyes and/or cause damage inside the product.

Precautions: Do not point the product directly at the sun.

 **WARNING** During dynamic applications, for example stakeout procedures there is a danger of accidents occurring if the user does not pay attention to the environmental conditions around, for example obstacles, excavations or traffic.

Precautions: The person responsible for the product must make all users fully aware of the existing dangers.

 **WARNING** Inadequate securing of the working site can lead to dangerous situations, for example in traffic, on building sites, and at industrial installations.

Precautions: Always ensure that the working site is adequately secured. Adhere to the regulations governing safety and accident prevention and road traffic.

 **CAUTION** If the accessories used with the product are not properly secured and the product is subjected to mechanical shock, for example blows or falling, the product may be damaged or people can sustain injury.

Precautions: When setting-up the product, make sure that the accessories are correctly adapted, fitted, secured, and locked in position. Avoid subjecting the product to mechanical stress.



	WARNING	<p>If the product is used with accessories, for example masts, staffs, poles, you may increase the risk of being struck by lightning.</p> <p>Precautions: Do not use the product in a thunderstorm.</p>
	CAUTION	<p>During the transport, shipping or disposal of batteries it is possible for inappropriate mechanical influences to constitute a fire hazard.</p> <p>Precautions: Before shipping the product or disposing of it, discharge the batteries by running the product until they are flat. When transporting or shipping batteries, the person in charge of the product must ensure that the applicable national and international rules and regulations are observed. Before transportation or shipping contact your local passenger or freight transport company.</p>
	WARNING	<p>High mechanical stress, high ambient temperatures or immersion into fluids can cause leakage, fire or explosions of the batteries.</p> <p>Precautions: Protect the batteries from mechanical influences and high ambient temperatures. Do not drop or immerse batteries into fluids.</p>
	WARNING	<p>If battery terminals are short circuited e.g. by coming in contact with jewellery, keys, metalized paper or other metals, the battery can overheat and cause injury or fire, for example by storing or transporting in pockets.</p> <p>Precautions: Make sure that the battery terminals do not come into contact with metallic objects.</p>
	WARNING	<p>If the product is improperly disposed of, the following can happen:</p> <ul style="list-style-type: none"> • If polymer parts are burnt, poisonous gases are produced which may impair health. • If batteries are damaged or are heated strongly, they can explode and cause poisoning, burning, corrosion or environmental contamination. • By disposing of the product irresponsibly you may enable unauthorised persons to use it in contravention of the regulations, exposing themselves and third parties to the risk of severe injury and rendering the environment liable to contamination. <p>Precautions:</p> <div data-bbox="416 1016 531 1150" data-label="Image"> </div> <p>The product must not be disposed with household waste. Dispose of the product appropriately in accordance with the national regulations in force in your country. Always prevent access to the product by unauthorised personnel.</p> <p>Product-specific treatment and waste management information is available from GeoMax AG.</p>
	WARNING	<p>Only GeoMax authorised service workshops are entitled to repair these products.</p>

1.6 Laser Classification

1.6.1 General

General

The following chapters provide instructions and training information about laser safety according to international standard IEC 60825-1 (2007-03) and technical report IEC TR 60825-14 (2004-02). The information enables the person responsible for the product and the person who actually uses the equipment, to anticipate and avoid operational hazards.

-  According to IEC TR 60825-14 (2004-02), products classified as laser class 1, class 2 and class 3R do not require:
 - laser safety officer involvement,
 - protective clothes and eyewear,
 - special warning signs in the laser working areaif used and operated as defined in this User Manual due to the low eye hazard level.
-  National laws and local regulations could impose more stringent instructions for the safe use of lasers than IEC 60825-1 (2007-03) and IEC TR 60825-14 (2004-02).

1.6.2 Distancer, Measurements with Reflectors

General

The EDM module built into the product produces a visible laser beam which emerges from the telescope objective.

The laser product described in this section is classified as laser class 1 in accordance with:

- IEC 60825-1 (2007-03): "Safety of laser products"
- EN 60825-1 (2007-10): "Safety of laser products"

These products are safe under reasonably foreseeable conditions of operation and are not harmful to the eyes provided that the products are used and maintained in accordance with this User Manual.

Description	Value
Maximum average radiant power	0.33 mW
Pulse duration	800 ps
Pulse repetition frequency (PRF)	100 MHz - 150 MHz
Wavelength	650 nm - 690 nm
Beam divergence	1.5 mrad x 3 mrad

Labelling

Class 1 Laser Product
according to IEC 60825-1
(2007 - 03)

Type: Zipp10 Pro Art.No.: XXXXXX
Power: 7.4V ^{max}, 1.4A max. CE
GeoMax AG S.No.: XXXXXX
CH-9443 Widnau 
Manufactured: 20XX
Made in China

Complies with FDA performance standards for laser products except for deviations pursuant to Laser Notice No. 50, dated June 24, 2007.
This device complies with part 15 of the FCC Rules. Operation is subject to the following two conditions:
(1) This device may not cause harmful interference, and
(2) this device must accept any interference received, including interference that may cause undesired operation.

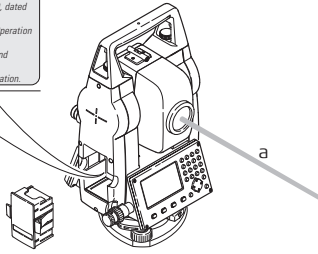

006920_001

a) Laser beam

1.6.3

Distancer, Measurements without Reflectors (NP mode)

General

The EDM module built into the product produces a visible laser beam which emerges from the telescope objective.

The laser product described in this section is classified as laser class 3R in accordance with:

- IEC 60825-1 (2007-03): "Safety of laser products"
- EN 60825-1 (2007-10): "Safety of laser products"

Direct intrabeam viewing may be hazardous (low eye hazard level), in particular for deliberate ocular exposure. The beam may cause dazzle, flash-blindness and after-images, particularly under low ambient light conditions. The risk of injury for laser class 3R products is limited because of:

- unintentional exposure would rarely reflect worst case conditions of (e.g.) beam alignment with the pupil, worst case accommodation,
- inherent safety margin in the maximum permissible exposure to laser radiation (MPE)
- natural aversion behaviour for exposure to bright light for the case of visible radiation.

Description	Value
Maximum average radiant power	5.00 mW
Pulse duration	800 ps
Pulse repetition frequency	100 MHz - 150 MHz
Wavelength	650 nm - 690 nm
Beam divergence	0.2 mrad x 0.3 mrad
NOHD (Nominal Ocular Hazard Distance) @ 0.25 s	80 m / 262 ft



CAUTION

From a safety perspective, class 3R laser products should be treated as potentially hazardous.

Precautions:

- 1) Prevent direct eye exposure to the beam.
- 2) Do not direct the beam at other people.



CAUTION

Potential hazards are not only related to direct beams but also to reflected beams aimed at reflecting surfaces such as prisms, windows, mirrors, metallic surfaces, etc.

Precautions:

- 1) Do not aim at areas that are essentially reflective, such as a mirror, or which could emit unwanted reflections.
- 2) Do not look through or beside the optical sight at prisms or reflecting objects when the laser is switched on, in laser pointer or distance measurement mode. Aiming at prisms is only permitted when looking through the telescope.

Labelling

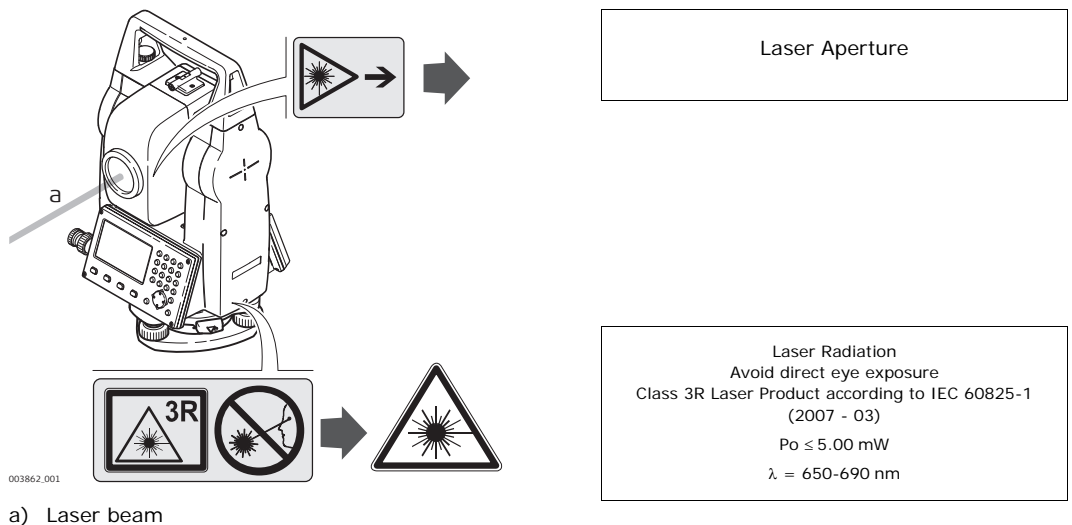

Type: Zipp10 Pro Art.No.: XXXXXX
 Power: 7.4V \pm , 1.4A max. CE
 GeoMax AG CH-9443 Widnau S.No.: XXXXXX
 Manufactured: 20XX Made in China
 Complies with FDA performance standards for laser products except for deviations pursuant to Laser Notice No. 50, dated June 24, 2007.
 This device complies with part 15 of the FCC Rules. Operation is subject to the following two conditions:
 (1) This device may not cause harmful interference, and
 (2) this device must accept any interference received, including interference that may cause undesired operation.

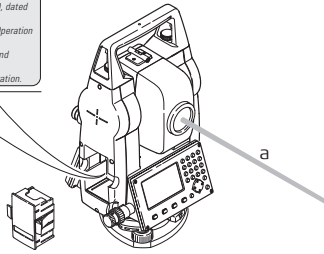

006920_001

1.6.4

Laser Plummet

General

The laser plummet built into the product produces a visible red laser beam which emerges from the bottom of the product.

The laser product described in this section is classified as laser class 2 in accordance with:

- IEC 60825-1 (2007-03): "Safety of laser products"
- EN 60825-1 (2007-10): "Safety of laser products"

These products are safe for momentary exposures but can be hazardous for deliberate staring into the beam. The beam may cause dazzle, flash-blindness and after-images, particularly under low ambient light conditions.

Description	Value
Maximum radiant power	0.95 mW \pm 5%
Duty cycle	14%, 22%, 35%, 70%
Pulse repetition frequency	1 kHz
Beam divergence	< 1.5 mrad
Beam diameter at aperture (1/e)	2.0 mm x 1.5 mm



CAUTION

From a safety perspective, class 2 laser products are not inherently safe for the eyes.

Precautions:

- 1) Avoid staring into the beam.
- 2) Avoid pointing the beam at other people.

Labelling

Type: Zipp10 Pro Art.No.: XXXXXX
 Power: 7.4V \pm , 1.4A max. CE
 GeoMax AG CH-9443 Widnau S.No.: XXXXXX
 Manufactured: 20XX Made in China
 Complies with FDA performance standards for laser products except for deviations pursuant to Laser Notice No. 50, dated June 24, 2007.
 This device complies with part 15 of the FCC Rules. Operation is subject to the following two conditions:
 (1) This device may not cause harmful interference, and
 (2) this device must accept any interference received, including interference that may cause undesired operation.

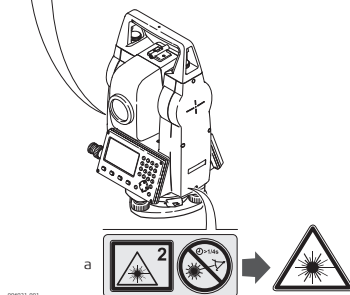

006921_001

a) Will be replaced by a class 3R warning label if applicable

Laser Radiation
 Do not stare into the beam
 Class 2 Laser Product
 according to IEC 60825-1
 (2007 - 03)
 $P_o \leq 1.00$ mW
 $\lambda = 620 - 690$ nm

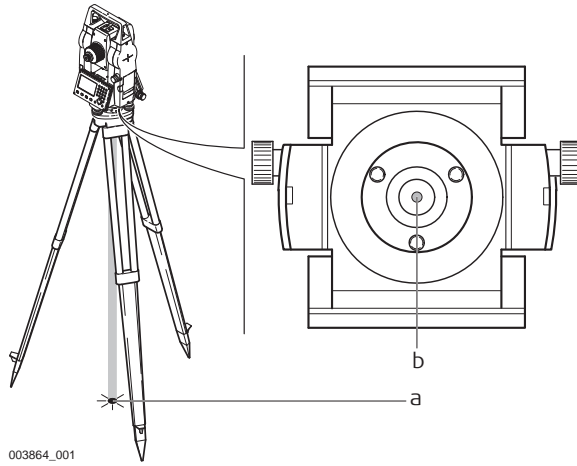

003864_001

- a) Laser beam
- b) Exit for laser beam

1.7 Electromagnetic Compatibility EMC

Description

The term Electromagnetic Compatibility is taken to mean the capability of the product to function smoothly in an environment where electromagnetic radiation and electrostatic discharges are present, and without causing electromagnetic disturbances to other equipment.

WARNING

Electromagnetic radiation can cause disturbances in other equipment.

Although the product meets the strict regulations and standards which are in force in this respect, GeoMax cannot completely exclude the possibility that other equipment may be disturbed.

CAUTION

There is a risk that disturbances may be caused in other equipment if the product is used with accessories from other manufacturers, for example field computers, personal computers or other electronic equipment, non-standard cables or external batteries.

Precautions:

Use only the equipment and accessories recommended by GeoMax. When combined with the product, they meet the strict requirements stipulated by the guidelines and standards. When using computers or other electronic equipment, pay attention to the information about electromagnetic compatibility provided by the manufacturer.

CAUTION

Disturbances caused by electromagnetic radiation can result in erroneous measurements. Although the product meets the strict regulations and standards which are in force in this respect, GeoMax cannot completely exclude the possibility that the product may be disturbed by intense electromagnetic radiation, for example, near radio transmitters, two-way radios or diesel generators.

Precautions:

Check the plausibility of results obtained under these conditions.

CAUTION

If the product is operated with connecting cables attached at only one of their two ends, for example external supply cables, interface cables, the permitted level of electromagnetic radiation may be exceeded and the correct functioning of other products may be impaired.

Precautions:

While the product is in use, connecting cables, for example product to external battery, product to computer, must be connected at both ends.

⚠ WARNING

This equipment has been tested and found to comply with the limits for a Class B digital device, pursuant to part 15 of the FCC rules.

These limits are designed to provide reasonable protection against harmful interference in a residential installation.

This equipment generates, uses and can radiate radio frequency energy and, if not installed and used in accordance with the instructions, may cause harmful interference to radio communications. However, there is no guarantee that interference will not occur in a particular installation.

If this equipment does cause harmful interference to radio or television reception, which can be determined by turning the equipment off and on, the user is encouraged to try to correct the interference by one or more of the following measures:

- Reorient or relocate the receiving antenna.
- Increase the separation between the equipment and the receiver.
- Connect the equipment into an outlet on a circuit different from that to which the receiver is connected.
- Consult the dealer or an experienced radio/TV technician for help.

⚠ WARNING

Changes or modifications not expressly approved by GeoMax for compliance could void the user's authority to operate the equipment.

Labelling Zipp10 Pro

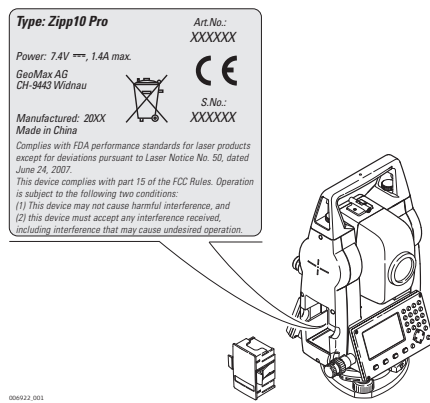

Labelling internal battery ZBA301

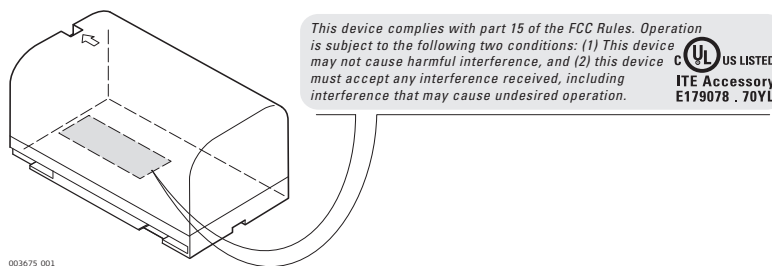

2 Description of the System

2.1 System Components

Main Components

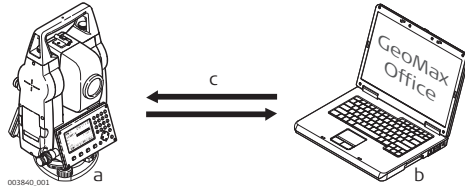

- a) Zipp10 Pro instrument
- b) Computer with GeoMax Office software
- c) Data transfer

Component	Description
Zipp10 Pro instrument	An instrument for measuring, calculating and capturing data. Ideally suited for tasks from simple surveys to complex applications. The instrument can be connected with GeoMax Office to view, exchange and manage data.
Firmware	The firmware package installed on the instrument. Consists of a standard base operating system.
GeoMax Office software	An office software consisting of a suite of standard programs for the viewing, exchanging, managing and post processing of data.
Data transfer	Data can be always transferred between an instrument and a computer via a data transfer cable or USB memory stick.

2.2 Container Contents

Container contents

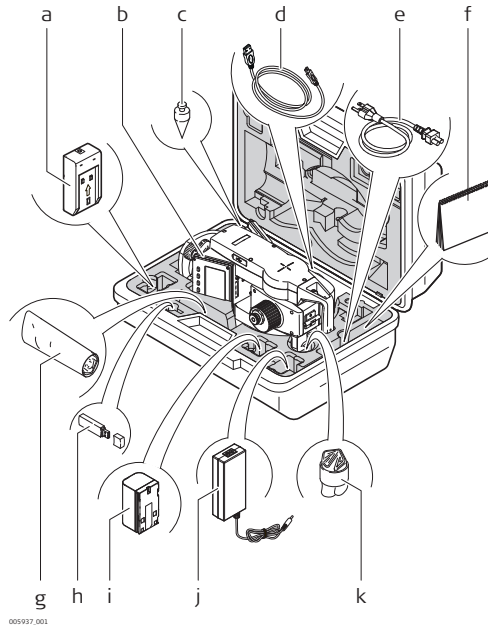

- a) ZCH301 battery charger
- b) Instrument with supplied tribrach
- c) Plumb bob
- d) ZDC301 USB cable
- e) Power cable for battery charger
- f) Manual
- g) Adjustment tools
- h) USB memory stick
- i) ZBA301 battery
- j) Adapter for charger
- k) Protective cover

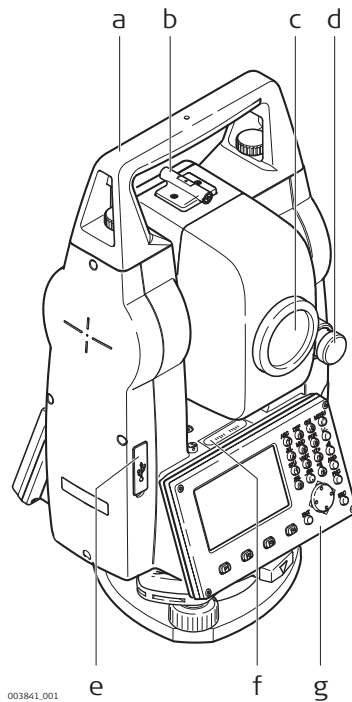
Instrument components
part 1 of 2

- a) Detachable carrying handle with mounting screw
- b) Optical sight
- c) Objective with integrated Electronic Distance Measurement (EDM). Exit for EDM laser beam
- d) Vertical drive
- e) Compartment for USB cable port and USB host port
- f) Leveling bubble
- g) Keyboard

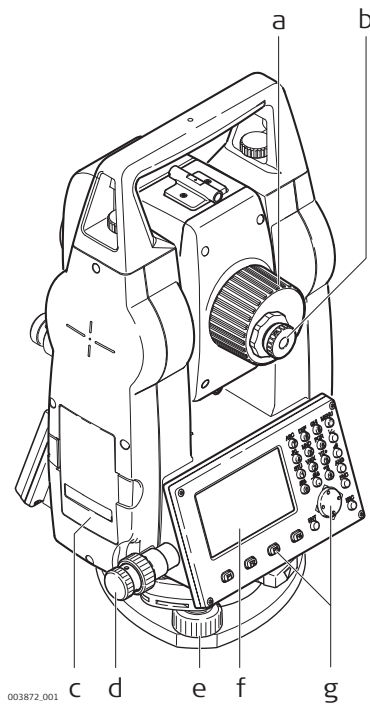
Instrument components
part 2 of 2

- a) Focusing telescope image
- b) Eyepiece; focusing graticule
- c) Battery cover
- d) Horizontal drive
- e) Foot screw
- f) Display
- g) Keyboard

3 User Interface

3.1 Keyboard

Alphanumeric keyboard

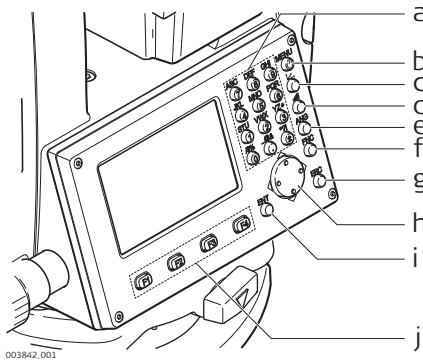

- a) Alphanumeric keypad
- b) **On/Off** key / **Menu** key
- c) Coordinate measurement key
- d) Distance measurement key
- e) **ANG** key
- f) **FNC** key
- g) **ESC** key
- h) Navigation key
- i) **ENT** key
- j) Function keys **F1** to **F4**

Keys

Key	Description
	Alphanumeric keypad for entry of text and numerical values.
	On/Off key. Turns instrument off when pressed for 2 s. When in Quick-Survey: accesses the Main Menu when pressed for 1 s.
	Coordinate measurement key. Switches to coordinate measurement mode when in Quick-Survey or Data Collect.
	Switches to distance measurement mode when in Quick-Survey or Data Collect.
	ANG key. Switches to angle measurement mode when in Quick-Survey or Data Collect.
	FNC key. Quick-access to measurement supporting functions.
	ESC key. Quits a screen or edit mode without saving changes. Returns to next higher level.
	Navigation key. Controls the focus bar within the screen and the entry bar within a field.
	ENTER key. Confirms an entry and continues to the next field.
	Function keys that are assigned the variable functions displayed at the bottom of the screen.

3.2 Screen

Screen

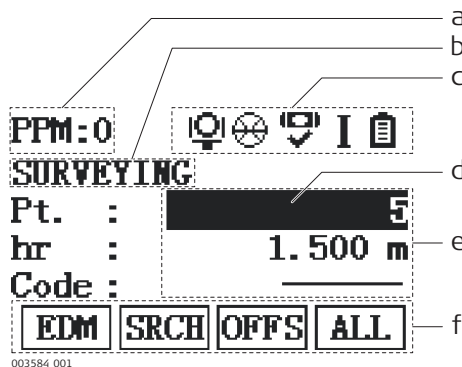

- a) PPM value
- b) Title of screen
- c) Status icons
- d) Focus in screen. Active field
- e) Fields
- f) Softkeys



All shown screens are examples. It is possible that local firmware versions are different to the basic version.

















3.3

Status Icons

Description

The icons provide status information related to basic instrument functions. Depending on the firmware version, different icons may be displayed.

Icons

Icon	Description
	The battery symbol indicates the level of the remaining battery capacity in 25% steps.
	Compensator is on.
	Compensator is off.
	P EDM mode for measuring to prisms.
	NP EDM mode for measuring to all targets.
	EDM mode for measuring to reflective foils.
	EDM type for measuring to 360° prism.
	EDM type for measuring to 360° Mini prism.
	EDM type for measuring to Custom prism.
	EDM type for measuring to Mini prism.
	EDM type for measuring to MiniJP prism.
	EDM type for measuring to Round prism.
	A double arrow indicates that a field has a selectable list.
	Up and down arrows indicate that several screens are available, which are accessed using the Navigation key or a softkey.
	Indicates that telescope position is face I.
	Indicates that telescope position is face II.

3.4

Softkeys

Description

Softkeys are selected using the relevant **F1** to **F4** function key. This chapter describes the functionality of the common softkeys used by the system. The more specialised softkeys are described where they appear in the program chapters.

Common softkey functions

Key	Description
ALPH	To change the keypad operation to alphanumerical.
NUM.	To change the keypad operation to numerical.
ALL	To start distance and angle measurements and save the measured values.
BACK	To return to the last active screen.
ENZ	To open the manual coordinate entry screen.
EDM	To view and change EDM settings. Refer to "5.2 EDM Settings".
MEAS	To start distance and angle measurements without saving the measured values.
OK	If entry screen: Confirms measured or entered values and continues the process. If message screen: Confirms message and continues with selected action or returns to the previous screen to reselect an option.
P/NP	To toggle between P and NP EDM modes.
LIST	To display the list of available points.
REC	To save the displayed values.
DEFL	To reset all editable fields to their default values.
SRCH	To search for an entered point.
VIEW	To display the coordinate and job details of the selected point.
P1↓	To display the next softkey level or select the next page.

3.5 Operating Principles

Turn instrument on/off Use the On/Off key.

Alphanumeric keypad The alphanumeric keypad is used to enter characters directly into editable fields.

- **Numeric fields:** Can only contain numerical values. By pressing a key of the keypad the number will be displayed.
- **Alphanumeric fields:** Can contain numbers and letters. By pressing a key of the keypad the first character written above that key will be displayed. By pressing several times you can toggle through the characters. For example: 1->S->T->U->1->S....

Edit fields



ESC Deletes any change and restores the previous value.



Moves the cursor to the left



Moves the cursor to the right.



Inserts a character at the cursor position.



Deletes the character at the cursor position.



In edit mode the position of the decimal place cannot be changed. The decimal place is skipped.

Special characters

Character	Description
*	Used as wildcards in search fields for point numbers or codes. Refer to "3.6 Pointsearch".
+/-	In the alphanumeric character set "+" and "-" are treated as normal alphanumeric characters with no mathematical function.  "+" / "-" only appear in front of an entry.

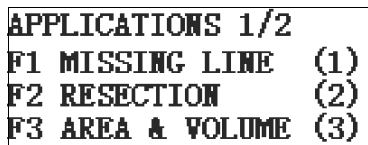

In this example selecting 2 on an alphanumeric keyboard would start the Resection application.

3.6 Pointsearch

Description Pointsearch is a function used by applications to find measured or fixed points in the memory storage. The pointsearch is limited to the current job. It is not possible to search the whole storage. The search procedure always finds fixed points before measured points that fulfil the same search criteria. If several points meet the search criteria, then the results are ordered according to the entry date. The instrument finds the most recent fixed point first.

Direct search By entering an actual point number, for example P404, and pressing **OK**, all points within the current job and with the corresponding point number are found.

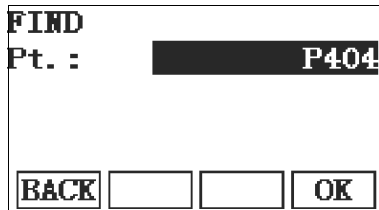

OK
To search for matching points within the current job.

Wildcard search The wildcard search is indicated by a "*". The asterisk is a place holder for any following sequence of characters. Wildcards should be used if the point number is not fully known, or to search for a batch of points.

Examples of point searches

- * All points are found.
- A All points with exactly the point number "A" are found.
- A* All points starting with "A" are found, for example, A9, A15, ABCD, A2A.
- *1 All points containing only one "1" are found, for example, 1, A1, AB1.
- A*1 All points starting with "A" and containing only one "1" are found, for example, A1, AB1, A51.

4

Operation

4.1

Instrument Setup

Description

This topic describes an instrument setup over a marked ground point using the laser plummet. It is always possible to set up the instrument without the need for a marked ground point.



Important features

- It is always recommended to shield the instrument from direct sunlight and avoid uneven temperatures around the instrument.
- The laser plummet described in this topic is built into the vertical axis of the instrument. It projects a red spot onto the ground, making it appreciably easier to centre the instrument.
- The laser plummet cannot be used with a tribrach equipped with an optical plummet.

Tripod

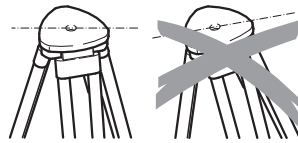

When setting up the tripod pay attention to ensuring a horizontal position of the tripod plate. Slight corrections of inclination can be made with the foot screws of the tribrach. Larger corrections must be done with the tripod legs.

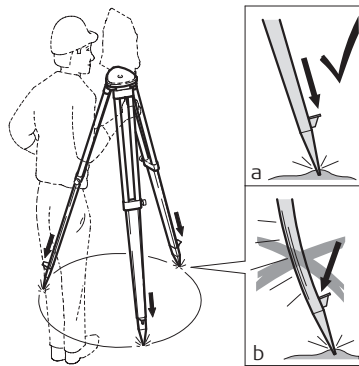

Loosen the clamping screws on the tripod legs, pull out to the required length and tighten the clamps.

- In order to guarantee a firm foothold sufficiently press the tripod legs into the ground.
- When pressing the legs into the ground note that the force must be applied along the legs.

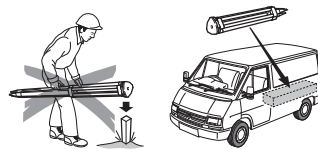

Careful handling of tripod.

- Check all screws and bolts for correct fit.
- During transport always use the cover supplied.
- Use the tripod only for surveying tasks.

Setup step-by-step

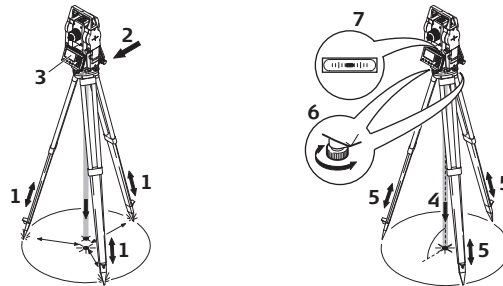

- 1 Extend the tripod legs to allow for a comfortable working posture. Position the tripod over the marked ground point, centring it as best as possible.
- 2 Fasten the tribrach and instrument onto the tripod.
- 3 Turn on the instrument, and, if tilt correction is set to 1- or 2-axis, the laser plummet will be activated automatically, and the **Level & Plummet** screen appears. Otherwise, press **FNC** from within any application and select **Lev & Plummet**.
- 4 Move the tripod legs (1) and use the tribrach footscrews (6) to center the plummet (4) over the ground point.
- 5 Adjust the tripod legs (5) to level the tubular level (7).
- 6 By using the electronic level, turn the tribrach footscrews (6) to precisely level the instrument. Refer to "Level up with the electronic level step-by-step".
- 7 Center the instrument precisely over the ground point by shifting the tribrach on the tripod plate (2).
- 8 Repeat steps 6 and 7 until the required accuracy is achieved.

Level up with the electronic level step-by-step

The electronic level can be used to precisely level up the instrument using the footscrews of the tribrach.

- 1) Turn the instrument until the tubular level is parallel to two footscrews.
- 2) Center the level on the instrument approximately by turning the footscrews of the tribrach.
- 3) Turn on the instrument, and, if tilt correction is set to 1- or 2-axis, the laser plummet will be activated automatically, and the **Level & Plummet** screen appears. Otherwise, press **FNC** from within any application and select **Lev & Plummet**.
- 4) Center the electronic level of the first axis by turning the two footscrews.
- 5) Center the electronic level for the second axis by turning the last footscrew.

 When the electronic level is centered and both axes are within the tolerance limit, the instrument has been levelled up.

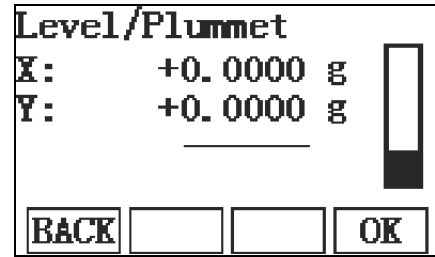

- 6) Accept with **OK**.

Change the intensity of the laser plummet

External influences and the surface conditions may require the adjustment of the intensity of the laser plummet.

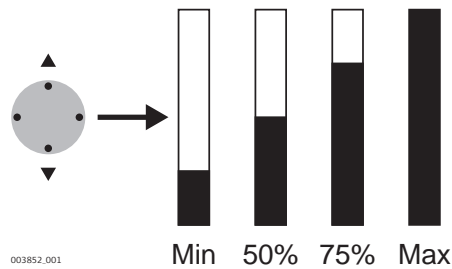

In the **Level & Plummet** screen, adjust the intensity of the laser plummet using the navigation key. The laser can be adjusted in 25% steps as required.

Position over pipes or holes

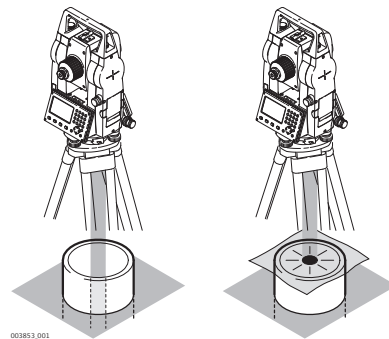

Under some circumstances the laser dot is not visible, for example over pipes. In this case, using a transparent plate enables the laser dot to be seen and then easily aligned to the center of the pipe.

4.2

Working with the Battery

Charging / first-time use

- The battery must be charged prior to using it for the first time because it is delivered with an energy content as low as possible.
- The permissible temperature range for charging is between 0°C to +40°C/+32°F to +104°F. For optimal charging we recommend charging the batteries at a low ambient temperature of +10°C to +20°C/+50°F to +68°F if possible.
- It is normal for the battery to become warm during charging. Using the chargers recommended by GeoMax, it is not possible to charge the battery if the temperature is too high.
- For new batteries or batteries that have been stored for a long time (> three months), it is effectual to make only one charge/discharge cycle.
- For Li-Ion batteries, a single discharging and charging cycle is sufficient. We recommend carrying out the process when the battery capacity indicated on the charger or on a GeoMax product deviates significantly from the actual battery capacity available.

Change the battery step-by-step

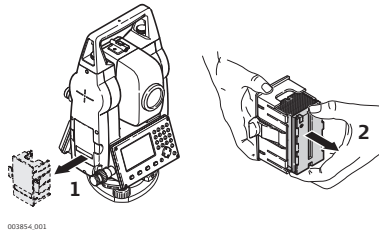

Remove the battery holder from the instrument (1).

Remove the battery from the battery holder (2).

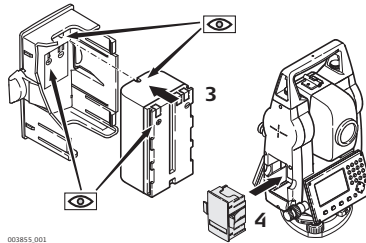

Insert the new battery into the battery holder (3), ensuring that the contacts are facing outward. The battery should click into position.

Insert the battery holder back into the battery compartment (4).

4.3

Data Storage

Description

An internal memory is included in all instruments. The firmware stores all data in jobs in a database in the internal memory. Data can then be transferred to a computer or other device for post processing via a cable connected to the USB port. Refer to "11 Data Management" for further information on data management and data transfer.

4.4

Main Menu

Description

The **MAIN MENU** is the starting place for accessing most functionality of the instrument. It is displayed when pressing the Menu key.

MAIN MENU

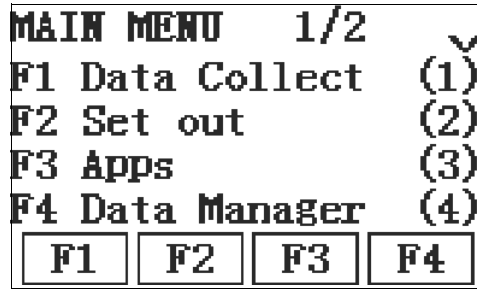

Description of the MAIN MENU functions

Function	Description
Data Collect	To select and start the Data Collect application. Refer to "10.2 Data Collect".
Set out	To select and start the Set out application. Refer to "10.5 Set Out".
Apps	To select and start applications. Refer to "10 Application".
Data Manager	To manage jobs, data, codelists, system memory and USB memory stick files. Refer to "11 Data Management".
Settings	To change EDM configurations and general instrument settings or access system information. Refer to "5 Settings".
Calibration	To calibrate the instrument. Refer to "12 Calibration".
Data Transfer	To export/import data. Refer to "11.2 Data Transfer".
Upload Firmware	To upload firmware files. Refer to "6 Loading Software".

4.5

Quick-Survey Application

Description

After switching on, the instrument is immediately ready for measuring.

Access

The **QUICK-SURVEY** screen is the default start screen after the instrument is turned on.

QUICK-SURVEY

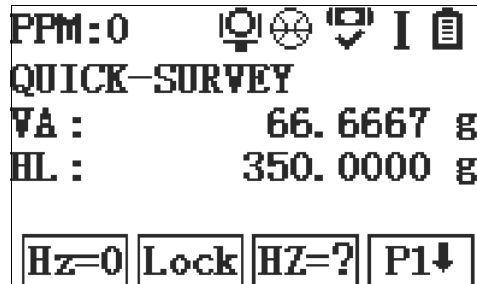

Depending on the measuring mode, a different screen is displayed.

The procedure for the **Quick-Survey** is identical to the procedure for the application **Data Collect** available under the **Main Menu**. Therefore this procedure is only described once within the application chapter. Refer to "10.2 Data Collect".

Quick-Survey softkeys

Depending on the selected measuring mode, different softkeys are displayed on the Quick-Survey screen.

Measuring Mode	Softkey	Description
Coordinate Measurement	P/NP	Toggle between prism and non prism mode.
	OFFS	Enter offset function.
	MEAS	Trigger measurement.
	hr	Enter target height.
	hi	Enter station height.
	STN	Enter station coordinates.

Measuring Mode	Softkey	Description
	m/ft	Toggle between distance unit meter and feet.
	EDM	Enter EDM settings.
Distance Measurement	P/NP	Toggle between prism and non prism mode.
	OFFS	Enter offset function.
	MEAS	Trigger measurement.
	m/ft	Toggle between distance unit meter and feet.
	S/O	Enter Set out application.
	EDM	Enter EDM settings.
Angle Measurement	HZ=0	Set horizontal angle to 0.
	Lock	Lock the horizontal angle.
	HZ=?	Enter and set a horizontal angle.
	COMP	Enter compensator settings.
	RMEA	Enter angle repeat measurement.
	V%	Toggle between vertical angle unit % and gon.
	R/L	Toggle between horizontal angle left and horizontal angle right.
	VA	Set vertical angle to Horizon = 0°.
ZA	Set vertical angle to Zenith = 0°.	

4.6 Distance Measurements - Guidelines for Correct Results

Description

A laser distancer (EDM) is incorporated into the Zipp10 Pro instruments. In all versions, the distance can be determined by using a visible red laser beam which emerges coaxially from the telescope objective. There are two EDM modes:

- Prism measurements (P)
- Reflectorless measurements (NP)

NP measurements

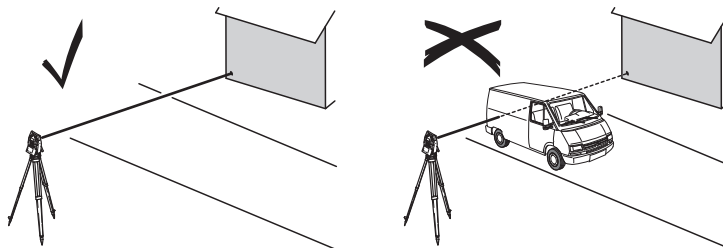

- When a distance measurement is triggered, the EDM measures to the object which is in the beam path at that moment. If a temporary obstruction, for example a passing vehicle, heavy rain, fog or snow is between the instrument and the point to be measured, the EDM may measure to the obstruction.
- Be sure that the laser beam is not reflected by anything close to the line of sight, for example highly reflective objects.
- Avoid interrupting the measuring beam while taking reflectorless measurements or measurements using reflective foils.
- Do not measure with two instruments to the same target simultaneously.

P measurements

- Accurate measurements to prisms should be made in P-Standard mode.
- Measurements to strongly reflecting targets such as traffic lights in Prism mode without a prism should be avoided. The measured distances may be wrong or inaccurate.
- When a distance measurement is triggered, the EDM measures to the object which is in the beam path at that moment. If for example people, cars, animals, or swaying branches cross the laser beam while a measurement is being taken, a fraction of the laser beam is reflected from these objects and may lead to incorrect distance values.
- Measurements to prisms are only critical if an object crosses the measuring beam at a distance of 0 to 30 m and the distance to be measured is more than 300 m.
- In practice, because the measuring time is very short, the user can always find a way of avoiding unwanted objects from interfering in the beam path.

Red laser to reflector foil

- The visible red laser beam can also be used to measure to reflective foils. To guarantee the accuracy the red laser beam must be perpendicular to the reflector foil and it must be well adjusted.
- Make sure the additive constant belongs to the selected target (reflector).

5

Settings

5.1



General Settings

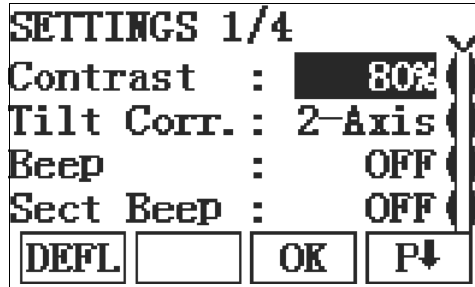

Access

- 1) Select **Setting** from the **MAIN MENU**.
- 2) Select **General** from the **SETTINGS** menu.
- 3) Press **F4** to scroll through the screens of available settings.

SETTINGS

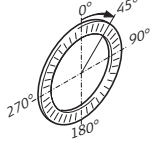
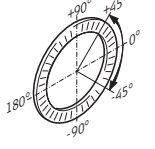
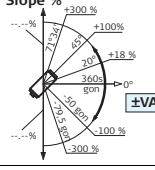

Field	Description
Contrast	0% to 100% Sets the display contrast in 10% steps.
Tilt Corr.	<p>OFF Tilting compensation deactivated.</p> <p>1-Axis Vertical angles refer to the plummet line.</p> <p>2-Axis Vertical angles refer to the plummet line and the horizontal directions are corrected by the standing axis tilt. For corrections depending on the HA Corr: setting, refer to the table "Tilt and horizontal corrections".</p> <p> If the instrument is used on an unstable base, for example a shaking platform or ship, the compensator should be deactivated. This avoids the compensator drifting out of it's measuring range and interrupting the measuring process by indicating an error.</p>
Beep	<p>The beep is an acoustic signal after each key stroke.</p> <p>Normal Normal volume.</p> <p>OFF Beep is deactivated.</p>
Sect Beep	<p>ON Sector Beep sounds at right angles (0°, 90°, 180°, 270° or 0, 100, 200, 300 gon).</p> <p>OFF Sector Beep is deactivated.</p>
AngUnit	<p>Sets the units shown for all angular fields.</p> <p>gon Gon. Possible angle values: 0 gon to 399.999 gon</p> <p>dec. de Degree decimal. Possible angle values: 0° to 359.999°</p> <p>mil Mil. Possible angle values: 0 to 6399.99mil.</p> <p>° ' " Degree sexagesimal. Possible angle values: 0° to 359°59'59"</p> <p> The setting of the angle units can be changed at any time. The actual displayed values are converted according to the selected unit.</p>
MinRead	<p>Sets the number of decimal places shown for all angular fields. This is for data display and does not apply to data export or storage.</p> <p>For Angle Unit ° ' "': (0° 00' 01" / 0° 00' 05" / 0° 00' 10").</p> <p>Dec.de: (0.0001 / 0.0005 / 0.001).</p> <p>Gon: (0.0001 / 0.0005 / 0.001).</p> <p>Mil: (0.01 / 0.001 / 0.05 / 0.1).</p>
DisUnit	<p>Sets the units shown for all distance and coordinate related fields.</p> <p>meter Meters [m].</p> <p>ft (US) US feet [ft].</p> <p>ft (INT) International feet [fi].</p> <p>ft-in/16 US feet-inch-1/16 inch [ft].</p>
Disp ill.	ON or OFF Sets the screen illumination on or off.

Field	Description	
HA Corr.	ON	Horizontal corrections are activated. For normal operation the horizontal correction should remain active. Each measured horizontal angle will be corrected, depending on the vertical angle. For corrections depending on the Tilt Corr : setting, refer to the table "Tilt and horizontal corrections".
	OFF	Horizontal corrections are deactivated.
HA Incr.	Right	Set horizontal angle to clockwise direction measurement.
	Left	Set horizontal angle to counter-clockwise direction measurement. Counter-clockwise directions are displayed but are saved as clockwise directions.
VA-Setting	Sets the vertical angle.	
	Zenith	Zenith=0°; Horizon=90°. 
	Horizon	Zenith=90°; Horizon=0°. Vertical angles are positive above the horizon and negative below it. 
Slope %	45° = 100%; Horizon=0°. Vertical angles are expressed in % with positive above the horizon and negative below it. The % value increases rapidly. ---% appears on the display above 300%. 	
Auto-OFF	Enable	The instrument switches off after 20 minutes without any activity, for example no key pressed or vertical and horizontal angle deviation is $\leq \pm 3^\circ$.
	Disabl	Automatic switch-off is deactivated.  Battery discharges quicker.
Temp. Unit	Sets the units shown for all temperature fields.	
	°C	Degree Celsius.
	°F	Degree Fahrenheit.
Press. Unit	Sets the units shown for all pressure fields.	
	hPa	Hecto Pascal.
	mbar	Millibar.
	mmHg	Millimeter mercury.
	inHg	Inch mercury.
Data Conf.	Sets the prompting for data confirmation.	
	ON	Data confirmation is activated.
	OFF	Data confirmation is deactivated.
StartUp DP	Sets which screen is accessed after the instrument is turned on.	
	Angle	Startup with angle measuring screen.
	Dist	Startup with distance measuring screen.

Tilt and horizontal corrections

Setting		Correction			
Tilt correction	Horizontal correction	Incline longitudinal	Incline transversal	Horizontal collimation	Tilting axis
Off	On	No	No	Yes	Yes
On	On	Yes	Yes	Yes	Yes
Off	Off	No	No	No	No
On	Off	Yes	No	No	No

Description The settings on this screen define the active EDM, Electronic Distance Measurement. Different settings for measurements are available with Reflectorless (NP) and Prism (P) EDM modes.

Access 1) Select **Setting** from the **MAIN MENU**.
2) Select **EDM** from the **SETTINGS** menu.

EDM SETTINGS

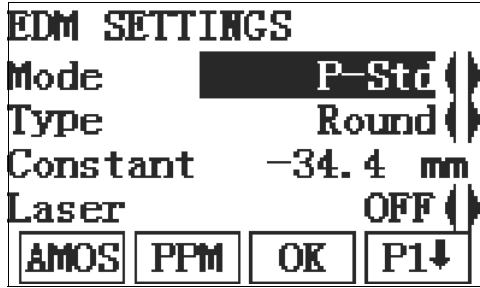

- AMOS**
To enter atmospheric data ppm.
- PPM**
To enter an individual ppm value.
- P↓ SCAL**
To enter projection scale details.
- P↓ SIGN**
To view EDM Signal reflection value.
- P↓ FREQ**
To view the EDM frequency.

Field	Description	
Mode	P-Std	Fine measuring mode for high precision measurements with prisms.
	P-Quick	Quick measuring mode with prisms, with higher measuring speed and reduced accuracy.
	P-Cont	For continuous distance measurements with prisms.
	NP-Std	For distance measurements without prisms.
	NP-Cont	For continuous distance measurements without prisms.
	Foil	For distance measurements using Retro reflective targets.
Type	Round	Standard prism Constant: -34.4 mm
	Mini	Mini prism Constant: -16.9 mm
	MinJP	MinJP Constant: 0.0 mm
	360°	360° prism Constant: -11.3 mm
	360° Mini	360° Mini prism Constant: -4.4 mm
	Custom	The user can define their own prism. Constants can be entered in mm in Constant .
	Foil	Constant: 0.0 mm
	None NP-modes Constant: 0.0 mm	
Constant	This field displays the absolute prism constant for the selected Type : Where Type : is Custom this field becomes editable to set a user defined constant. Input can only be made in mm. Limit value: -999.9 mm to +999.9 mm.	
Laser	OFF	Visible laser beam is deactivated.
	ON	Visible laser beam for visualising the target point is activated.

ATMOSPHERIC DATA ENTRY

This screen enables the entry of atmospheric parameters. Distance measurement is influenced directly by the atmospheric conditions of the air in which the measurements are taken. In order to take these influences into consideration distance measurements are corrected using atmospheric correction parameters. The refraction correction is taken into account in the calculation of the height differences and the horizontal distance. Refer to "14.6 Scale Correction" for the application of the values entered in this screen.

 When PPM=0 is selected, the GeoMax standard atmosphere of 1013 hPa, 12°C, and 60% relative humidity will be applied.

Free-PPM Entry

This screen enables the entry of individual scaling factors. Coordinates and distance measurements are corrected with the PPM parameter. Refer to "14.6 Scale Correction" for the application of the values entered in this screen.

PROJECTION SCALE

This screen enables entry of the scale of projection. Coordinates are corrected with the PPM parameter. Refer to "14.6 Scale Correction" for the application of the values entered in this screen.

EDM SIGNAL REFLECTION

This screen tests the EDM signal strength (reflection strength) in steps of 1%. Enables optimal aiming at distant, barely visible, targets. A percentage bar and a beeping sound, indicate the reflection strength. The faster the beep the stronger the reflection.

Description

The System Information screen displays instrument, system and firmware information, as well as settings for the date and time.

 Please provide the instrument-related information, such as instrument type and serial number, as well as the firmware version and build number when contacting support.

Access

- 1) Select **Setting** from the **MAIN MENU**.
- 2) Select **System Info.** from the **SETTINGS MENU**.

SYSTEM INFORMATION

This screen displays information about the instrument and operating system.

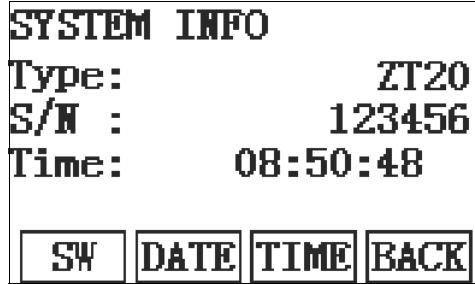

- SW**
To display details of the firmware package installed on the instrument.
- DATE**
To change the date and format.
- TIME**
To change the time.

Field	Description
Type	Displays the instrument type.
S/N	Displays the serial number of the instrument.
Time	Displays the time.

Next step

Press **SW** to view the firmware package information.

SOFTWARE-INFO

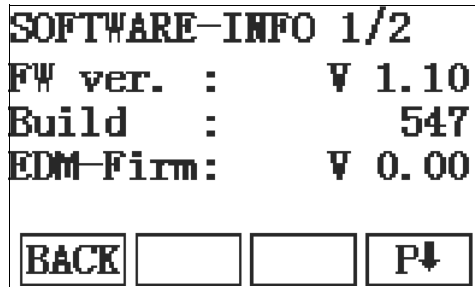

Field	Description
FW ver.	Displays the firmware version number installed on the instrument.
Build	Displays the build number of the firmware.
EDM-Firm	Displays the version number of the EDM firmware.
P↓ Application Information	Displays a list of the applications available on the instrument.

6

Loading Software

Description To load application software, connect the instrument to GGO via the serial interface or USB and load using "GGO - Software Upload". Refer to the GGO online help for further information. The software can be loaded via a USB memory stick. This process is described below.

Access

- 1) Select **Upload Fw** from the **MAIN MENU**.
- 2) Select **Firmware** from the **UPLOAD FIRMWARE**.



Never disconnect the power supply during the system upload process. The battery must be at least 75% capacity before commencing the upload.

Loading firmware and languages step-by-step

1. To load firmware: Select **Firmware**. The **Select File** screen will appear.
2. Select the firmware file from the system folder of the USB memory stick. The firmware file must be stored in the system folder to be transferred to the instrument.
3. Press **OK**.
4. Press **Yes** on the power warning message to proceed and upload the firmware.
5. Once successfully loaded, the system will shutdown and restart again automatically.

7 Functions

7.1 Overview

Description Functions can be accessed by pressing **FNC** from any measurement screen. **FNC** opens the functions menu and a function can be selected and activated.

Functions

Function	Description
Lev & Plummet	Activates the laser plummet and electronic level.
Illu. ON/OFF	Activates and deactivates the screen illumination light.
Data Confirm	Sets the prompting for data confirmation.
Del Last Obs.	Deletes the last recorded data block.  Deleting the last record is not reversible! Only records recorded in Data Collect can be deleted.
Laserbeam	Activates/deactivates the visible laser beam for illuminating the target point.
Settings	Refer to "5 Settings".
P/NP Change	Changes between the two EDM modes. Refer to "5.2 EDM Settings".
Compensator	Opens the Compensator screen. Refer to "5.1 General Settings".

7.2 Angle Offset

Description This function calculates the target point coordinates if it is not possible to set up the reflector, or to aim at the target point directly. The offset point and the measurement point must have the same distance to the instrument.

Access

- 1) Press **OFFS** when in distance or coordinate screen of Data Collect or Quick-Survey.
- 2) Select **Angle Offset** from the **Select method** menu.

ANGLE OFFSET

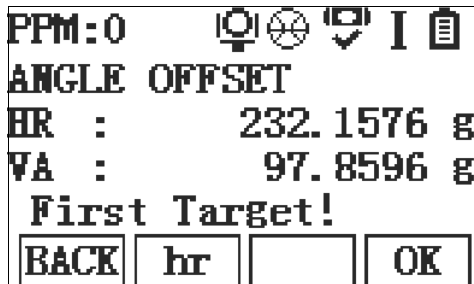

Field	Description
HR	Horizontal angle.
VA	Vertical angle.
VD	Height to the point.

Next step

- Press **OK** and measure the distance. Aim at the second target and press **OK** to calculate the offset point.

Description

This function calculates the target point coordinates if it is not possible to set up the reflector, or to aim at the target point directly. The offset values (length, trav. and/or height offset) can be entered. The values for the angles and distances are calculated to determine the target point.

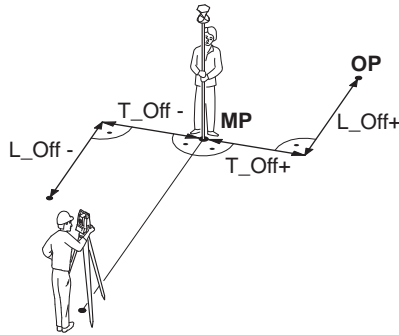

- MP Measurement point
- OP Offset point
- T_Off Length offset
- L_Off Cross offset

Access

- 1) Press **OFFS** when in distance or coordinate screen of Data Collect or Quick-Survey.
- 2) Select **Dist. Offset** from the **Select method** menu.

DISTANCE OFFSET

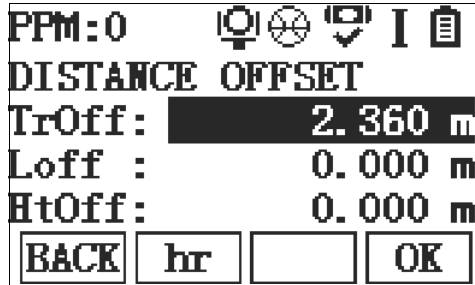

Field	Description
TrOff	Perpendicular offset. Positive if the offset point is to the right of the measured point.
Loff	Longitudinal offset. Positive if the offset point is further away than the measured point.
HtOff	Height offset. Positive if the offset point is higher than the measured point.
	The offset values are always remembered when the application is quit.

Next step

- Press **OK** and measure the distance. Confirm the measurement with **OK** to calculate the offset point.

Description

This function calculates the angle between two points by averaging repeated measurements. The measurements can be repeated as many times as necessary.

Access

1) Press **RMEA** when in angle screen of Data Collect or Quick-Survey.

**REPEATED ANGLE
MEASUREMENT**
Hz=0

To set the first point to HZ=0.

Rel.

To complete the measurement of the first target.

Lock

To lock the horizontal angle and start to remeasure the first point.

Field	Description
Num. of Meas	Number of repeated measurements.
Ht	Total of the horizontal angle.
Hm	Mean of the repeated horizontal angle measurements.

Next step

- Repeat the measurements as many times as necessary. Press **ESC** to exit the function.

Description

Codes contain information about recorded points. With the help of coding, points can be assigned to a particular group simplifying later processing.
Codes are stored in codelists, with each codelist supporting a maximum of 200 codes.

GSI coding

Codes are always stored as free codes (WI41-49), that means that codes are not directly linked to a point. They are stored before the measurement.
A code is always recorded for each measurement as long as the code is displayed in the **Code:** field. For a code not to be recorded, the **Code:** field must be cleared.

Access

Select **Data Manager** from the **MAIN MENU** and choose **Code Library**.

CODE-LIBRARY

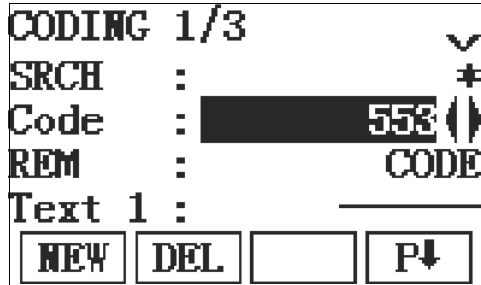

NEW

To enter a new code.

DEL

To delete the selected code.

Field	Description
SRCH	Code name. After entry, the firmware searches for a matching code name, and displays these in the code field.
Code	List of existing code names.
REM	Additional remarks.
Text 1 to Text 8	More information lines, freely editable. Used to describe attributes of the code.

Extend codes

To each code a description and a maximum of 8 attributes with up to 12 characters each can be assigned. Existing code attributes are displayed in fields **Text 1:** to **Text 8:**.

9 Applications - Getting Started

9.1 Overview

Description Applications are predefined programs, that cover a wide spectrum of surveying duties and facilitate daily work in the field. The following applications are available:

- Data Collect
- Missing Line Measurement
- Resection
- Set Out
- Area & Volume
- Remote Elevation
- Road Stakeout

9.2 Starting an Application

Access

- 1) Select **Apps** from the **MAIN MENU**. **Data Collect** and **Set out** can be directly accessed over the **Main Menu**.
- 2) Use the Navigation key to move through the screens of available applications.
- 3) Press a function key, **F1 - F4**, to select the specified application in the **APPLICATIONS** menu.

Pre-settings screens Pre-settings for Data Collect is shown as an example. Any additional settings for particular applications are explained within the chapters for those applications.

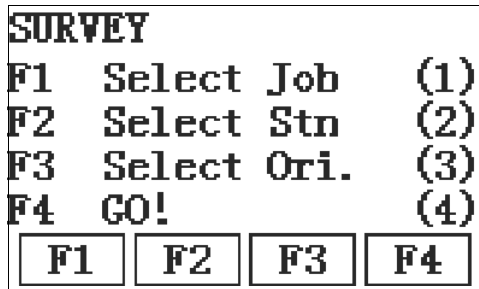

F1-F4
To select menu item.

Field	Description
Select Job	To define the job where data will be saved. Refer to "9.3 Selecting the Job".
Select Stn	To define the current position of the instrument station. Refer to "9.4 Selecting the Station".
Select Ori.	To define the orientation and horizontal direction of the instrument station. Refer to "9.5 Selecting the Orientation".
GO!	Starts the selected application.

Description

All data is saved in Jobs, like file directories. Jobs contain measurement data of different types, for example measurements, codes, fixed points, or stations. Jobs are individually manageable and can be exported, edited or deleted separately.

Access

Select **Select Job** in **Pre-settings** screen.

SELECT JOB

The screenshot shows a terminal-style interface for selecting a job. At the top, it says "SELECT JOB 2/2". Below that, the following fields are displayed: "Job : J101" (with a cursor on the right), "User: ABC", "Date: 09.11.2011", and "Time: 12:56:27". At the bottom, there are four buttons: "NEW", an empty box, another empty box, and "OK".

NEW
To create a new job.

Field	Description
Job	Name of an existing job to be used.
User	Name of user, if entered.
Date	Date the selected job was created.
Time	Time the selected job was created.

Next step

- Either, press **OK** to continue with the selected job.
- Or, press **NEW** to open the **NEW JOB** screen and create a new job.

Recorded data

Once a job is set up, all subsequent recorded data will be stored in this job. If no job was defined and an application was started and a measurement was recorded, then the system automatically creates a new job and names it "DEFAULT".

Next step

Press **OK** to confirm the job and return to the **Pre-Settings** screen.

Description

All measurements and coordinate computations are referenced to the set station coordinates. The station coordinates that are set must include:

- at least grid coordinates (E, N), and
- the station height, if required.

The coordinates can be entered manually or selected from the memory.

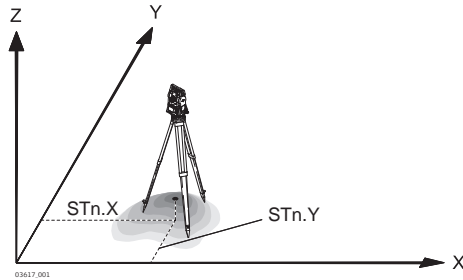

Directions

- X Easting
- Y Northing
- Z Height

Station coordinates

- Stn.X Easting coordinate of station
- Stn.Y Northing coordinate of station

Access

Select **Select Stn** in the **Pre-settings** screen.

Station input

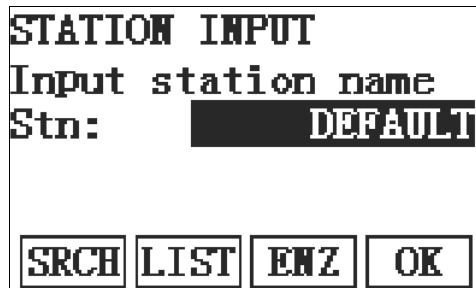

Field	Description
Stn	Station name of a previously saved station position.



If no station was set and an application was started, or if in **Survey** and a measurement was recorded, then the last station is set as the current station.

Next step

The **Inst.Ht.** field appears once the station coordinates have been entered. Enter the instrument height if desired and press **OK** to return to the **Pre-Settings** screen.

9.5 Selecting the Orientation

9.5.1 Overview

Description All measurements and coordinate computations are referenced to the orientation of the set station. The orientation can be entered manually or determined from points that are either measured or selected from the memory.

Access Select **Select Ori.** in the **Pre-settings** screen and choose:

- **Angle** to enter a new bearing. Refer to "9.5.2 Manual Orientation".
- **Coordinates** to calculate and set the orientation using existing coordinates.

9.5.2 Manual Orientation

Access Select **Angle** in the **ORIENTATION** screen.

MANUAL ANGLE SETTING

MANUAL ANGLE SETTING
hr : 1.500 m
Brg. : 0.0000 g
Aim at target?
NO [] HA=0 YES

HA=0
To set the bearing to 0.

Field	Description
hr	Height of the reflector.
Brg.	Horizontal direction of the station.

Next step

- Press **YES** set the orientation and return to the **Pre-Settings** screen.
- Press **NO** return to the **Pre-Settings** screen. No changes will be saved.

9.5.3 Orientation with Coordinates

Access Select **Coordinates** in the **ORIENTATION** screen.

Orientation with coordinates

Field	Description
BS ID	Point ID of the backsight point.

Next step

Find an existing backsight point in the pointsearch or enter ENZ coordinates for a new point. Press **OK** to continue to **Sight target point**.

Sight target point

Field	Description
Brg.	Horizontal direction of the station.

Next step

- Press **YES** to set the orientation and return to the Pre-Settings screen.
- Press **NO** to return to the **ORIENTATION** screen. No changes will be saved.



If no orientation was set and an application was started, or if in **Quick-Survey** and a measurement was made, then the current horizontal direction is set as the orientation.

Next step Select **GO!** to begin the application.

10

Application

10.1

Common Fields

Description of fields

The following table describes common fields that are found within the firmware applications. These fields are described here once and not repeated in the application chapters unless the field has a specific meaning within that application.

Field	Description
Pt, Pt 1	Point ID of the point.
hr	Height of the reflector.
HR	Horizontal direction to the point.
VA	Vertical angle to the point.
HD	Horizontal distance to the point.
SD	Slope distance to the point.
VD	Height to the point.
E	Easting coordinate of the point.
N	Northing coordinate of the point.
Z	Height coordinate of the point.

10.2

Data Collect

Description

Data Collect is an application used for the measurement of an unlimited number of points. It is comparable to **Quick-Survey** from the start screen, but data is recorded and it includes pre-settings for the job, station and orientation prior to beginning a survey.

Access

- 1) Select **Data Collect** from the **MAIN MENU**.
- 2) Complete application pre-settings. Refer to "9 Applications - Getting Started".

SURVEYING

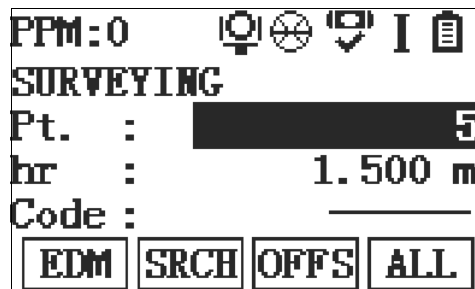

Field	Description
Code	Code name. This text is stored with the corresponding measurement. The code can be related to a codelist. A codelist on the instrument is not necessary.

Next step

- Either, press **ALL** to record another point.
- Or, press **ESC** to exit the application.

Description

Missing Line Measurement is an application used to compute slope distance, horizontal distance, height difference and azimuth of two target points which are either measured, selected from the memory, or entered using the keypad.

Missing Line Measurement methods

- The user can choose between two different methods:
- Polygonal: P1-P2, P2-P3, P3-P4.
 - Radial: P1-P2, P1-P3, P1-P4.

Polygonal method

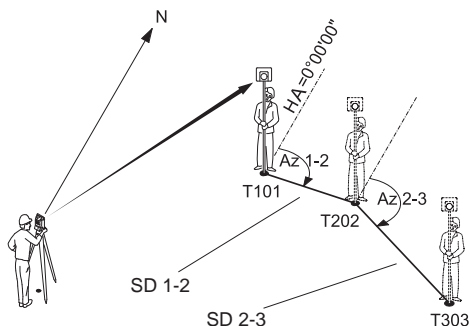

- T101 1st target point
- T202 2nd target point
- T303 3rd target point
- SD 1-2 Slope distance from T101-T202
- SD 2-3 Slope distance from T202-T303
- Az 1-2 Azimuth from T101-T202
- Az 2-3 Azimuth from T202-T303

Radial method

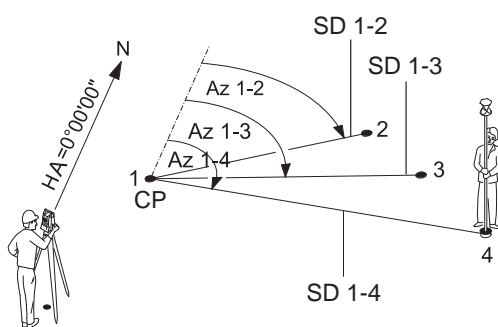

- 1-4 Target points
- SD 1-2 Slope distance from 1-2
- SD 1-3 Slope distance from 1-3
- SD 1-4 Slope distance from 1-4
- Az 1-2 Azimuth from 1-2
- Az 1-3 Azimuth from 1-3
- Az 1-4 Azimuth from 1-4
- CP Center point

Access

- 1) Select **Apps** from the **MAIN MENU**.
- 2) Select **MISSING LINE** from the **APPLICATIONS** menu.
- 3) Complete application pre-settings. Refer to "9 Applications - Getting Started".
- 4) Select **POLYGON** or **RADIAL**.

Missing line measurements

After completing the measurements required, the Missing Line result screen will appear.

MISSING LINE RESULT - Polygonal method

```

PPM:0  [Icons]
MISSING LINE POLY.
d. HD: 4.996 m
dz : 0.471 m
HZ : 303.0017 g
NewT NewP [ ] RADI
    
```

- NewT**
To calculate an additional line. Application starts again at point 1.
- NewP**
To set point 2 as the starting point of a new line. A new point 2 must be measured.
- RADI**
To switch to radial method.

Field	Description
d. HD	Horizontal distance between point 1 and point 2.
dz	Height difference between point 1 and point 2.
HZ	Azimuth between point 1 and point 2.

**MISSING LINE RESULT -
Radial method**

PPM:0	♀ ⊕ ♀ I
MISSING LINE RAD.	
d. HD:	4.996 m
dZ :	0.471 m
HZ :	303.0017 g
CtrlP	EndP
	POLY

- CtrlP**
To calculate an additional line. Application starts again at point 1.
- EndP**
To measure a new point 2.
- POLY**
To switch to polygonal method.

Field	Description
d. HD	Horizontal distance between point 1 and point 2.
dZ	Height difference between point 1 and point 2.
HZ	Azimuth between point 1 and point 2.

Next step Press **ESC** to exit the program.

10.4 Resection

10.4.1 Starting Resection

Description

Resection is an application used to determine the instruments position from measurements to known points. A minimum of two known points and a maximum of 5, can be used to determine the position.

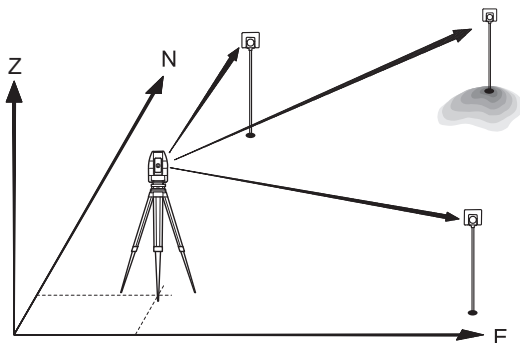

Access

- 1) Select **Apps** from the **MAIN MENU**.
- 2) Select **RESECTION** from the **APPLICATIONS** menu.
- 3) Complete application pre-settings. Refer to "9 Applications - Getting Started".
- 4) **Select Select Acc.** to set accuracy limit:
 - **ON** to activate a warning message if the calculated standard deviation exceeds the limit.
 - Set the accuracy limits for the Easting, Northing and Height coordinates and the standard deviation angle.
 - **OFF** to deactivate that a warning message is shown.
 - Press **OK** to save the limits and return to the **Pre-settings** screen.
- 5) Select **GO!** to begin the application.

Enter target data

Enter the name of the station and the height of the instrument in the **Station data** screen and press **OK**.

Next step

To access the **Sight target point** screen:

- Press **OK** after entering the target data fields in the **Target data** screen.

Sight target point

In the **Sight target point** screen:

2 / I: Indicates that the second point was measured in face I.

2 / I II: Indicates that the second point was measured in faces I and II.

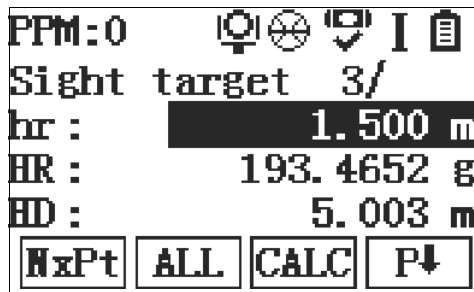

CALC

To calculate and display the station coordinates, if at least two points and a distance were measured.

NxPt

To return to the **Enter target data** screen to select the next known point.

Next step

- Either, press **NxPt** to measure the next known point.
- Or, press **CALC** to calculate the station position.

10.4.2

Measuring Information

Measurement sequences

The following measurement sequences are possible:

- Horizontal direction and vertical-angles only (resection)
- Distance and horizontal direction and vertical-angle
- Horizontal direction and vertical-angles to some point(s) and horizontal direction and vertical angles plus distance to other point(s).

Single face I, single face II, or dual face I and II measurements are always possible. No specific point sequence or specific face sequences are required.

Dual face measurements

When measuring the same target in both faces, the reflector height may not be changed when observing in the second face. Error checks are made for dual face measurements to ensure the same point is sighted with the other face.



- If a target point is measured several times in the same face, only the last valid measurement is used for computation.
- For the calculation of the station position, measured target points can be re-measured.

Measurements not included in computations

Target points with 0.000 height are discarded for height processing. If a target point has a valid height of 0.000 m, use 0.001 m to include it for height processing.

10.4.3

Computation Procedure

Description

The measuring procedure automatically determines the method of evaluation, for example resection or three point resection.

If more than the minimum required measurements are performed, the procedure uses a least squares adjustment to determine the 3D position and averages orientation and height measurements.

- The original averaged face I and face II measurements are used for the computation process.
- All measurements are treated with the same accuracy, whether these are measured in single or dual face.
- Easting and Northing are determined by the least squares method, which includes standard deviation and improvements for horizontal direction and horizontal distances.
- The final height (H) is computed from averaged height differences based on the original measurements.
- The horizontal direction is computed with the original averaged face I and face II measurements and the final computed plan position.

Access Press **CALC.** from the **Sight target point** screen after at least two points and a distance have been measured.

STATION COORDINATES This screen displays calculated station coordinates. The final computed results are Easting, Northing and Height coordinates of the present instrument station, including the instrument height. Standard deviations and residuals for accuracy assessments are provided.

```

Stn:          999
hi :          1.400 m
NO:          -3.782 m
EO:          -7.666 m
ZO:          1.600 m
[BACK] [RESI] [S. D.] [OK]
    
```

RESI
To display residuals. Refer to "Target Residuals".

S. D.
To display the standard deviation of the coordinates and angle.

 If the instrument height was set to 0.000 in the setup screen, then the station height refers to the height of the tilting axis.

Next step
Press **RESI** to display the target residuals.

Target Residuals The **TARGET RESIDUALS** screen displays the computed residuals for the horizontal and vertical distances and the horizontal direction. Residual = Calculated value - Measured value.

Messages The following are important messages or warnings that may appear.

Messages	Description
Invalid point data!	This message occurs if the selected target point has no Easting or Northing coordinate.
Max 5 points supported!	5 points have already been measured and another point is selected. The system supports a maximum of 5 points.
No position recorded due to bad data!	<ul style="list-style-type: none"> - The measurements may not allow final station coordinates (Eastings, Northings) to be computed. - Either the target height is invalid or insufficient measurements are available to compute a final station height.
Remeasure point in Face I and II.	<ul style="list-style-type: none"> - This error occurs if a point was measured in one face and the measurement in the other face differs by more than $180^\circ \pm 0.9^\circ$ for the horizontal angle. - This error occurs if a point was measured in one face and the measurement in the other face differs by more than $360^\circ - VA \pm 0.9^\circ$ for the vertical angle.

Next step Press **OK** to return to the **APPLICATION** menu.

Description

Set Out is an application used to place marks in the field at predetermined points. These predetermined points are the points to be staked. The points to be staked may already exist in a job on the instrument, or be manually entered. The application can continuously display differences, between current position and desired set out position.

Set Out modes

Points can be staked using different modes: Polar mode, Orthogonal to station mode and Cartesian mode.

Polar Set Out mode

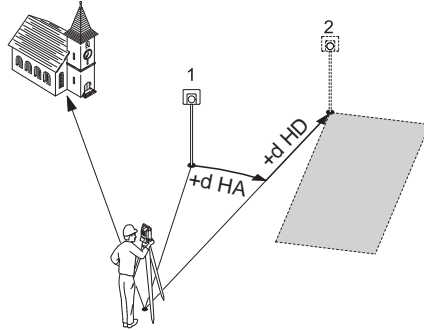

- 1 Current position
- 2 Point to be set out
- dHD Longitudinal offset: positive if point to be setout is further away.
- dHA Angle offset: positive if point to be setout is to the right of the actual direction.

Orthogonal to Station Set Out mode

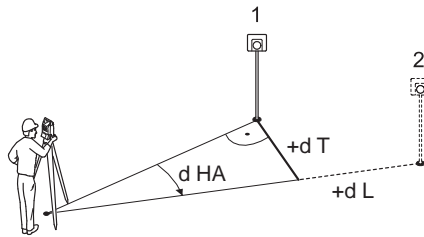

- 1 Current position
- 2 Point to be set out
- dL Longitudinal offset: positive if nominal point is further away.
- dT Transversal offset, perpendicular to line-of-sight: positive if nominal point is to the right of the measured point.
- dHA Angle offset: positive if nominal point is to the right of the actual direction.

Cartesian Set Out mode

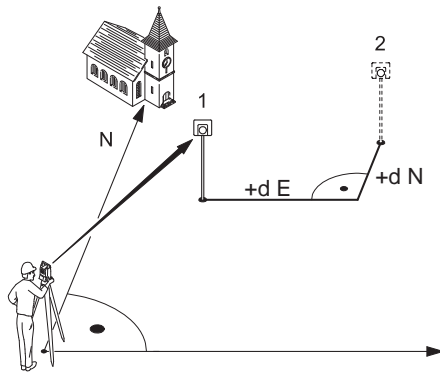

- 1 Current position
- 2 Point to be set out
- d E Easting offset between point to be set out and actual point.
- d N Northing offset between point to be set out and actual point.

Access

- 1) Select **Set out** from the **MAIN MENU**.
- 2) Complete application pre-settings. Refer to "9 Applications - Getting Started".

SET OUT

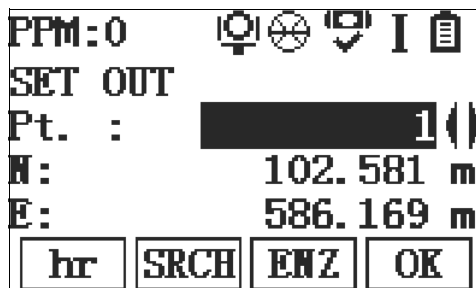

hr
To enter the reflector height.

Next step

Press **SRCH** to find an existing point with the pointsearch or enter ENZ coordinates for a new point. Press **OK** to continue the stakeout.

Set out - compute

PPM: 0

COMPUTE

HZ = 88.9707 g

HD = 595.077 m

Ang. [] Off. Crd.

Ang.

To enter the polar set out screen.

Off.

To enter the orthogonal set out screen.

Crd.

To enter the cartesian set out screen.

Mode	Field	Description
Polar set out	HZ	Computed horizontal angle.
	dHZ	Angle offset: Positive if set out point is to the right of the measured point.
Orthogonal set out	dLen	Longitudinal offset: Positive if set out point is further away than the measured point.
	dTra	Perpendicular offset: Positive if set out point is to the right of the measured point.
	dz	Height offset: Positive if set out point is higher than the measured point.
Cartesian set out	dN	Northing offset: Positive if set out point is further away than the measured point.
	dE	Easting offset: Positive if set out point is to the right of the measured point.
	dZ	Height offset: Positive if set out point is higher than the measured point.

Next step

- Either, press **MEAS** to start measurements for a set out point.
- Or, press **ESC** to exit the application.

Description

Area is an application used to compute online areas to a maximum of 50 points connected by straights. The target points have to be measured, selected from memory, or entered via the keypad in a clockwise direction. The calculated area is projected onto the horizontal plane (2D) or projected onto the sloped reference plane defined by three points (3D). Furthermore a volume with constant height can be calculated in relation to the area (2D/3D).

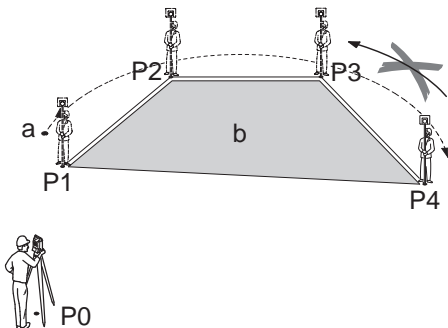

- P0 Instrument station
- P1 Start point
- P2-4 Target points
- a Perimeter, polygonal length from start point to the current measured point.
- b Calculated area always closed to the start point P1, projected onto the horizontal plane.

Access

- 1) Select **Apps** from the **MAIN MENU**.
- 2) Select **Area** from the **APPLICATIONS** menu.
- 3) Complete application pre-settings. Refer to "9 Applications - Getting Started".

AREA & VOLUME

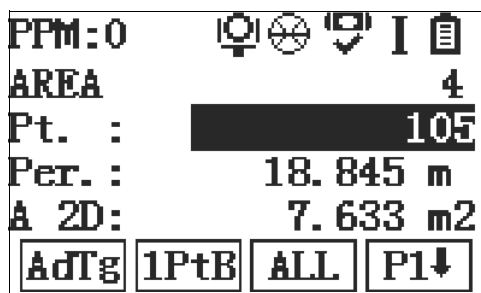

- AdTg**
To add a point from the memory.
- 1PtB**
To undo measurement or selection of the previous point.
- P↓ CALC**
To display and record additional results.
- P↓ VOL**
To calculate a volume with constant height. The heights have to be entered or measured.
- P↓ 3D**
To define the sloped reference plane by selecting or measuring three points.



The 2D area is calculated and displayed once three points have been measured or selected. The 3D area is calculated once the sloped reference plane is defined by three points.

Graphical representation

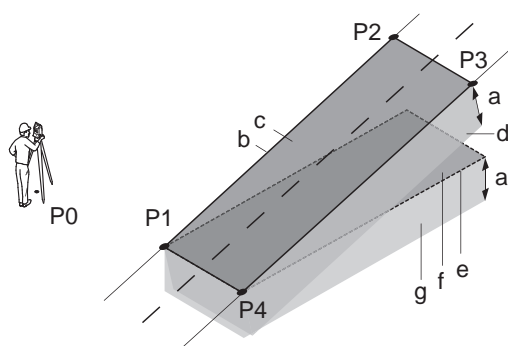

- P0 Instrument station
- P1 Target point which defines the sloped reference plane
- P2 Target point which defines the sloped reference plane
- P3 Target point which defines the sloped reference plane
- P4 Target point
- a Constant height
- b Perimeter (3D), polygonal length from the start point to the current measured point of the area (3D)
- c Area (3D), projected onto the sloped reference plane
- d Volume (3D) = a x c
- e Perimeter (2D), polygonal length from the start point to the current measured point of the area (2D)
- f Area (2D), projected onto the horizontal plane
- g Volume (2D) = f x a

Next step
Press **CALC** to calculate area and volume and proceed to the **Area & Volume Result** screens.



Perimeter are updated if further area points are added.

Next step

- Either, press **New** to define a new area.
- Or, press **AdTg** to add a new target point to the existing area.
- Or, press **ESC** to exit the application.

10.7

Remote Elevation

Description

Remote Elevation is an application used to compute points directly above the base prism without a prism at the target point.

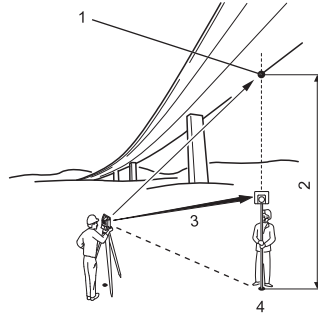

- 1 Remote point
- 2 Height difference
- 3 Slope distance
- 4 Base point

Access

- 1) Select **Apps** from the **MAIN MENU**.
- 2) Select **REMOTE ELEVAT** from the **APPLICATIONS** menu.
- 3) Complete application pre-settings. Refer to "9 Applications - Getting Started".

Remote elevation measurement

Measure to the base point or press **P↓ hr=?** to determine an unknown reflector height.

Next step

After measuring, the **REMOTE ELEVATION** screen appears.

REMOTE ELEVATION - Aim at remote point

Aim the instrument at the inaccessible remote point.

Field	Description
dZ	Calculated difference in height between the base point and the remote point.

Next step

- Either, press **SAVE** to save the measurement of the remote point.
- Or, press **BASE** to enter and measure a new base point.
- Or, press **ESC** to exit the application.

Description

Road Alignment is an application used to measure or set out points relative to a defined element. The element can be a line, curve or spiral. Chainage, incremental set outs and offsets (left and right) are supported.

 The definition and upload of horizontal alignments is done with the Road Editor in GeoMax Office.

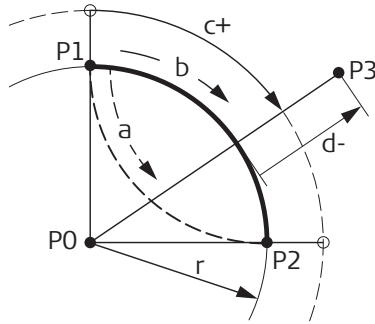

- P0 Center point
- P1 Start point of arc
- P2 End point of arc
- P3 Point to set out
- a Anti-clockwise
- b Clockwise
- c+ Distance from start of arc, following curve
- d- Perpendicular offset from arc
- r Radius of arc

Access

- 1) Select **Apps** from the **MAIN MENU**.
- 2) Select **Road Stakeout** from the **APPLICATIONS** menu.
- 3) Complete application pre-settings. Refer to "9 Applications - Getting Started"

Road submenu

The Road Application has the following submenus:

Menu selection	Description
Define Route	To view and enter control points which can be used for station setup and orientation. To define the horizontal alignment.
Setout	To stakeout points on the alignment or relative to the alignment. To measure transections.
View Result	To view results of transection and stakeout.
Data Transfer	To upload and download road data.

Elements

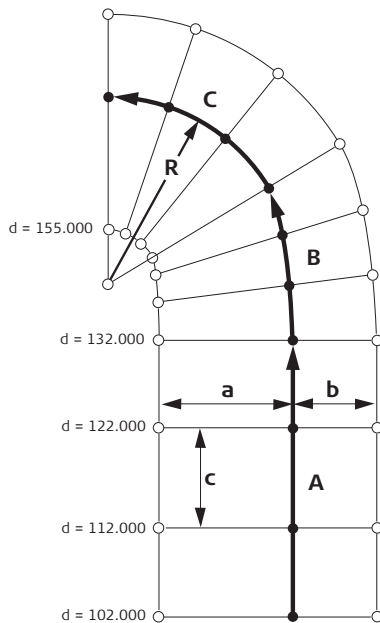

- A Straight
- B Spiral
- C Curve
- R Radius
- a Perpendicular offset left
- b Perpendicular offset right
- c Increment
- d Stationing

Define the element step-by-step

1. Select **DEFINE ROUTE** in the **ROAD SETOUT** screen.
2. Select **Horiz. Alig.** in the **Route Definition** screen.
3. Select **Main Point** in the **SELECT HORIZ ALIGN** screen.
4. Press **ADD**.
5. Select the element and enter the parameters in the **NEW MAIN POINT** screen.

- SAVE**
To save the new main point
- Chck**
To check the alignment
- END**
To exit the screen

6. For a line element:
 - Enter the chainage, radius and the start point coordinates.
 7. For a curve element:
 - Enter the chainage, the radius at start point and the start point coordinates.
- For a spiral element:
- Enter the chainage, the radius at start point and the start point coordinates.

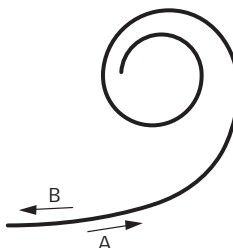

- Spiral type**
- A Spiral in
- B Spirial out

8. For an End Point:
 - Enter the chainage, the radius and the start point coordinates.
9. After all elements are saved press **END** to leave **NEW MAIN POINT** screen.

Cross Points

Cross points are the intersection points of two tangents of a symmetric alignment. Cross points can be used to define a complete road alignment.

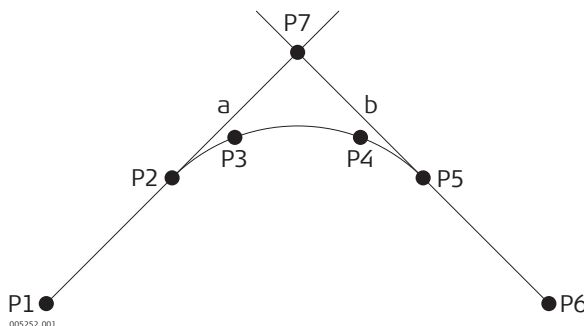

- P1 Start point straight 1
- P2 Start point spiral 1
- P3 Start point circle
- P4 Start point spiral 2
- P5 Start point straight 2
- P6 End point
- P7 Cross point
- a Tangent 1
- b Tangent 2

Enter Cross Points

1. Select **DEFINE ROUTE** in the **ROAD SETOUT** screen.
2. Select **Horiz. Alig.** in the **Route Definition** screen.
3. Select **Cross Point** in the **SELECT HORIZ ALIGN** screen.
4. Select **ADD** in the **VIEW CROSS POINT** screen and enter cross points.

- SAVE**
To save the new cross point
- Chck**
To check the alignment
- END**
To exit screen

5. After entering the cross points press **END** to leave **Cross Point** menu.
6. Enter **VIEW MAIN POINT** menu to view the calculated main points.
 - ☞ Start and end element have to be a straight or rather an end point.
 - ☞ At least two cross points have to be entered. The first cross point is the start point of the straight.

Field	Description
E	East coordinate of cross point.
N	North coordinate of cross point.
Turning	Angle of intersection between the two tangents.
Rad	Radius of the corresponding curvature.
Spiral	Length of corresponding spiral. If there is no spiral enter 0.

Stakeout Middle and Offset Points

1. Select **Setout** in the **ROAD SETOUT** screen.
2. Select **Mid/Side Pile** in the **Setout Measurement** screen.

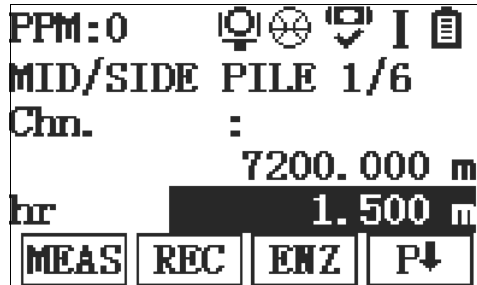

- P↓ Redo**
To go back one increment
- P↓ SAVE**
To save current measurement as control point
- P↓ REC**
To save measurement and increase chainage by pile space
- P↓ Proj**
To set current chainage to projected point

Field	Description
Chn.	Chainage
hr	Reflector height
Bear.	Angle offset: Positive if set out point is to the right of the measured point.
Back	Horizontal offset: Positive if set out point is further away than the measured point.
Left	Longitudinal offset: Positive if set out point is to the right of the measured point.
REM	Remark
Proj. Pile:	Projection of current measurement point to the middle axis of the alignment.
Width	Deviation of the current measured point to the middle axis.
dChn.	Chainage difference between projected pile and stakeout chainage.
Space	Chainage increment.
Offset	Entered offset value.
HZ	Angle between stakeout point and middle axis if point is perpendicular to the axis HZ=100 gon.

Measure Transection

1. Select **Setout** in the **ROAD SETOUT** screen.
2. Select **Transect Meas** in the **Setout Measurement** screen.

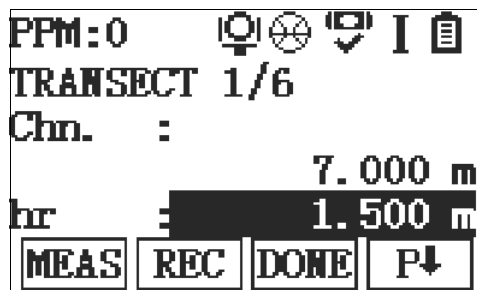

- DONE**
To finish the current transection and increase the chainage by the entered pile space
- P↓ SAVE**
To save current measurement as control point

Field	Description
Width:	Deviation of the current measured point to the middle axis.
dChn:	Chainage difference between projected pile and stakeout chainage.
dZ	Height difference between current point and previous point.
REM	Remark
St.Chn:	Chainage of the current station.
N:	North coordinate
E:	East coordinate

Field	Description
Z:	Height coordinate
Space:	Chainage increment
Bear.:	Angle between measured point and middle axis.

Upload and Download Road Alignment

Road data can be created in GeoMax Office and uploaded to the instrument. Road data can be also downloaded to the computer. Before downloading or uploading the data a connection between the instrument and a PC has to be established in the Road editor of GeoMax Office.

1. Select **Data Transfer** in the **ROAD SETOUT** screen.

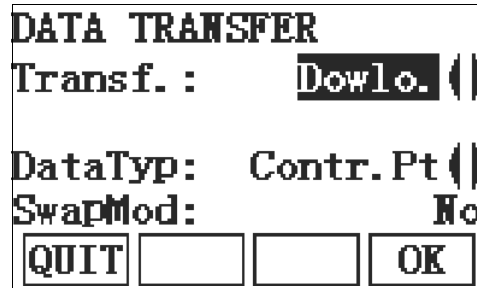

QUIT
To exit screen

Field	Description
Transf.:	To download or upload data.
DataTyp:	Select, which kind of data is transferred: control points, horizontal alignment, transaction or stakeout measurements.
SwapMod:	Displays if identical data is overwritten or kept.

-  The transfer mode and the data type have to be the same on the instrument and the Road editor in GeoMax Office.

Access

Select **Data Manager** from the **MAIN MENU**.

DATA MANAGER

The Data Manager menu contains all functions for entering, editing, checking and deleting data in the field.

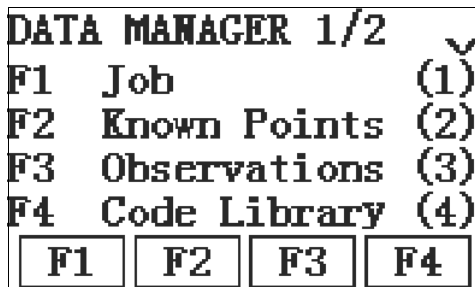

F1-F4
To select menu item.

Menu item	Description
Job	To view, create and delete jobs. Jobs are a summary of data of different types, for example, known points, observations or codes. The job definition consists of the job name and user. The system generates time and date at the time of creation.
Known points	To view, create, edit and delete known points. Valid fixed points contain at least the point ID and the coordinates E, N or H.
Observations	To view and delete observation data. Observation data available in the internal memory can be searched for via a specific point search, or by viewing all points within a job.
Code Library	To view, create, edit and delete codes. To each code a description and a maximum of 8 attributes with up to 12 characters each can be assigned.
Erase Memory	To delete individual jobs, known points and measurements of a specific job or all jobs in the memory.  Deleting the memory cannot be undone. After confirming the message all data is permanently deleted.
Memory Info	Displays job specific memory information such as the number of stored stations and known points within a job, the number of recorded data blocks, for example measured points, or codes within a job, and the memory space occupied.

Next step

- Either, select a menu option using **F1 - F4**.
- Or, press **ESC** to return to the **MAIN MENU**.

11.2

Data Transfer

11.2.1

Exporting Data

Description

Job data can be exported from the internal memory of the instrument. Data can be exported via:

The USB port

A receiver, such as a laptop, is connected to the USB port. The receiver requires GGO Data Exchange Manager or another third party software.



If the receiver is too slow in processing data the data could be lost. With this type of data transfer the instrument is not informed about the performance of the receiver (no protocol). Therefore the success of this type of transfer is not checked.

A USB memory stick

A USB memory stick can be inserted and removed from the USB host port. No additional software is required for the transfer.

Access

- 1) Select **Data Transfer** from the **MAIN MENU**.
- 2) Select **Export**.

DATA EXPORT

```
DATA EXPORT
To      USB-Stick
Type    Observa.
Sel. J  :      123
[BACK] [SRCH] [LIST] [OK]
```

SRCH

To search for jobs within the internal memory.

LIST

To list all jobs within the internal memory.

Field	Description
To	USB memory stick
Type	Data type to be transferred. Observa., Fixed Pts or Obs/Fix Pt
Sel. J	The job selected for export.

Export data step-by-step

- 1) Press **OK** in the **DATA EXPORT** screen after selecting the export details.
- 2) Select the data format and press **OK**.
- 3) If the data format is ASCII, the **ASCII Format** screen appears. Continue with the next step. For all other data format types, a message will display confirming the successful export of data.
- 4) Define the delimiter value, the units and the data fields of the file and press **OK**. A message will display confirming the successful export of data.

```
ASCII Format 1/3
Delimit.  comma
Unit      meter
Header    No
[OK] [DEFL] [ ] [P↓]
```



Road data can only be exported using Office software. An export to a USB memory stick is not supported.

Exportable job data formats

Job data can be exported from a job in a variety of file types.

Example job data output

Within the **Data Type** setting **Observations**, a data set could be shown as follows:

11....+00000D19	21..022+16641826	22..022+09635023
31..00+00006649	58..16+00000344	81..00+00003342
82..00-00005736	83..00+00000091	87..10+00001700

GSI-IDs			GSI-IDs continued		
11	△	Pt	41-49	△	Codes and attributes
21	△	Horizontal direction	51	△	ppm [mm]
22	△	Vertical angle	58	△	Prism constants
25	△	Orientation	81-83	△	(E, N, H) Target point
31	△	Slope distance	84-86	△	(E, N, H) Station point
32	△	Horizontal distance	87	△	Reflector height
33	△	Height difference	88	△	Instrument height

11.2.2

Importing Data

Description

Data can be imported to the internal memory of the instrument via a USB memory stick.

Importable data formats

Job data can be imported. The following data format can be imported:

Data Type	File extension	Recognised as
GSI	.gsi	Known points
ASCII	.txt	Known points

Access

- 1) Select **Data Transfer** from the **MAIN MENU**.
- 2) Select **Import**.

DATA IMPORT

```

DATA IMPORT
From :   USB-Stick
To :    Instrument
File :   SingleFile

[BACK] [ ] [ ] [OK]
    
```

Field	Description
From	USB-Stick
To	Instrument
File	Single File

Import data step-by-step

- 1) Press **OK** in the **DATA IMPORT** screen to proceed to the USB memory stick file directory.
- 2) Select the file on the USB memory stick to be imported and press **OK**.
- 3) Define the Job name for the imported file and press **OK** to import. If a Job with the same name already exists in the internal memory, a message will appear with the options to overwrite the existing job or rename the job for the file being imported.
- 4) If the file is an ASCII file, the **ASCII Format** screen will appear. Define the delimiter value, the units and the data fields of the file and press **OK** to continue.
- 5) A message will display once the file has been successfully imported.

```

ASCII Format 1/2
Delimit.  comma
Unit      meter
Start Line  1

[OK] [DEFL] [ ] [P↓]
    
```



Road data can only be imported using Office software. An import from a USB memory stick is not supported.

11.3

Working with a USB Memory Stick

Insert a USB memory stick step-by-step

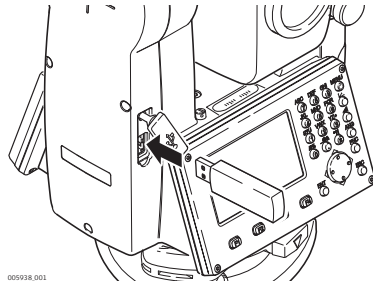

Lift the lid covering the USB host port on the instrument.

Insert the USB memory stick into the USB host port.



Always return to the **Main Menu** before removing the USB memory stick.



GeoMax cannot be held responsible for data loss or any other error that may occur when using a USB memory stick.



- Keep the USB memory stick dry.
 - Use it only within the specified temperature range.
 - Protect the USB memory stick from direct impacts.
- Failure to follow these instructions could result in data loss and/or permanent damage to the USB memory stick.

11.4

Working with GeoMax Office

Description

The software GeoMax Office is used for the data exchange between the instrument and a computer. It contains several auxiliary programs in order to support the instrument.

Installation on a computer

The installation program can be found on the DVD supplied. Insert the DVD and follow the on-screen instructions. Please note that GeoMax Office can only be installed on computers with MS Windows 98, 2000, 7 and XP operating systems.



For more information about GeoMax Office refer to the help.

Loading software and languages

To load application software or languages, connect the instrument to GeoMax Office via the USB port and load using "GeoMax Office - Onboard software update". Refer to the GeoMax Office help for further information.

12

Calibration

12.1

Overview

Description

GeoMax instruments are manufactured, assembled and adjusted to a high quality. Quick temperature changes, shock or stress can cause deviations and decrease the instrument accuracy. It is therefore recommended to calibrate the instrument from time to time. This can be done in the field by running through specific measurement procedures. The procedures are guided and have to be followed carefully and precisely as described in the following chapters. Some other instrument errors and mechanical parts can be adjusted mechanically.

Electronic calibration

The following instrument errors can be checked and calibrated electronically:

- Horizontal collimation error, also called line-of-sight error.
- Vertical index error, and simultaneously the electronic level.



For determining these errors, it is necessary to measure in both faces, but the procedure can be started in any face.

Mechanical calibration

The following instrument parts can be calibrated mechanically:

- Level on the instrument and tribrach.
- Laser plummet.
- Screws on the tripod.



During the manufacturing process, the instrument errors are carefully determined and set to zero. As mentioned, these errors can change and it is highly recommended to redetermine them in the following situations:

- Before the instrument is used for the first time.
- Before every high precision survey.
- After rough or long periods of transport.
- After long periods of work or storage.
- If the temperature difference between current environment and the temperature at the last calibration is more than 10°C (18°F).

12.2

Preparation



Before determining the instrument errors, level-up the instrument using the electronic level. The **Level & Plummet** is the first screen to appear after turning on the instrument. The tribrach, the tripod and the ground should be very stable and secure from vibrations or other disturbances.



The instrument should be protected from direct sunlight in order to avoid thermal expansion on one side only.



Before starting to work, the instrument has to become acclimatised to the ambient temperature. Approximately two minutes per °C of temperature difference from storage to working environment, but at least 15 min, should be taken into account.

Line-of-sight error

The line-of-sight error, or horizontal collimation error is the deviation from the perpendicular between the tilting axis and the line of sight. The effect of the line-of-sight error to the horizontal direction increases with the vertical angle.

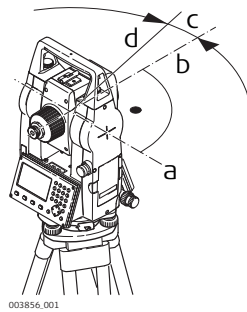

- a) Tilting axis
- b) Line perpendicular to tilting axis
- c) Horizontal collimation, or line-of-sight, error
- d) Line-of-sight

Vertical index error

The vertical circle should read exactly 90° (100 gon) when the line of sight is horizontal. Any deviation from this figure is termed vertical index error. This is a constant error that affects all vertical angle readings.

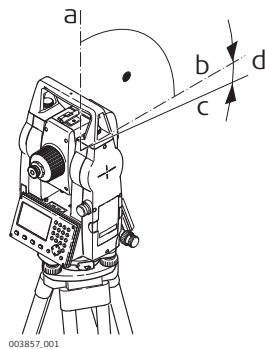

- a) Mechanical vertical axis of the instrument, also called standing axis
- b) Axis perpendicular to the vertical axis. True 90°
- c) Vertical angle is reading 90°
- d) Vertical index error

By determining the vertical index error the electronic level is adjusted automatically

Access

- 1) Select **Calibration** from the **MAIN MENU**.
- 2) Select a calibration option from the **CALIBRATION** screen.

Calibration options

In the **CALIBRATION** screen there are several calibration options.

Menu selection	Description
HA-Collimatn	Refer to "12.3 Calibrating Line-of-Sight and Vertical Index Error".
Vert. Index	Refer to "12.3 Calibrating Line-of-Sight and Vertical Index Error".
View Calib.	Displays the current calibration values and compensator indexes that have been set for HA-Collimation and V-index.



The procedures and conditions required to correct line-of-sight and vertical index errors are the same, therefore the procedure will only be described once.

Calibration step-by-step

1) Level the instrument with the electronic level. Refer to "4 Operation"- "Level up with the electronic level step-by-step".

2

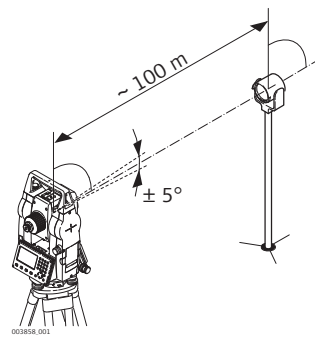

Aim at a point approximately 100 m from the instrument which is within 5° of the horizontal.

3 Press **REC** to measure to the target point.

4

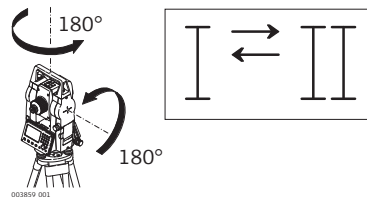

Change face and aim at the target point again



For checking the horizontal aim, the difference in HA and VA are displayed.

5 Press **REC** to measure to the target point.



The old and new calculated values are displayed.

6 Either:

- Press **OK** to save the new calibration data, or
- Press **ESC** to exit without saving the new calibration data.

Messages

The following are important messages or warnings that may appear.

Messages	Description
VA not suitable for calibration !	The vertical angle deviates from the required horizontal / line-of-sight, or in face II the vertical angle deviates by more than 5° from the target point. Aim at the target point with an accuracy of min. 5°. Confirmation of the message required.
Results out of tolerance. Previous values retained !	Computed values out of tolerance. The previous values are retained and measurements should be repeated. Confirmation of the message required.
HA not suitable for calibration !	Horizontal angle in face II deviates by more than 5° from the target point. Aim on the target point with an accuracy of min. 5°. Confirmation of the message required.
Measurement Error. Try again.	Measurement error appears when, for example, there is an unstable set up. Repeat the process. Confirmation of the message required.
Time limit exceeded ! Please repeat adjustment!	Time difference between measurements for results storage exceeds 15 minutes. Repeat the process. Confirmation of the message required.

Calibrate the level step-by-step

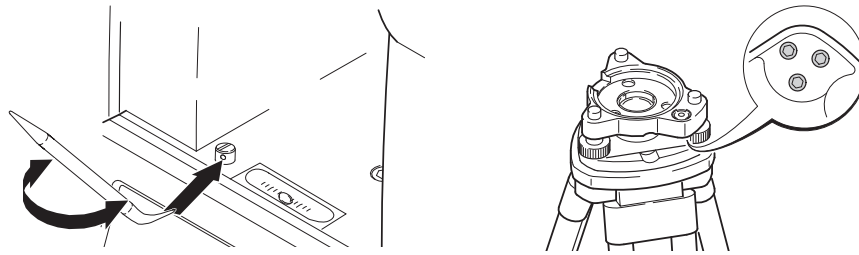

- 1 Place and secure the tribrach onto the tripod, and then secure the instrument onto the tribrach.
- 2 Using the tribrach footscrews, level the instrument with the electronic level. To activate the electronic level, turn on the instrument, and, if tilt correction is set to 1- or 2-axis, the **Level & Plummet** screen appears automatically. Alternatively, press **FNC** from within any application and select **Level & Plummet**.
- 3 The bubbles of the instrument and tribrach levels must be centered. If one or both levels are not centered, adjust as follows.

Instrument: If the bubble extends beyond the lines, use the Allen key supplied to center it with the adjustment screws.

Tribrach: If the bubble extends beyond the circle, adjust it using the adjustment pin in conjunction with the adjustment screws. Turn the adjustment screws:

- To the left: and the bubble approaches the screw.
- To the right: and the bubble goes away from the screw.

- 4 Repeat step 3 on the instrument and tribrach until both levels are centered and no further adjustments are necessary.



After the calibration, no adjustment screw should be loose.

12.5

Inspecting the Laser Plummet of the Instrument



The laser plummet is integrated into the vertical axis of the instrument. Under normal conditions of use, the laser plummet does not need adjusting. If an adjustment is necessary due to external influences, the instrument has to be returned to a GeoMax service department.

Inspect the laser plummet step-by-step

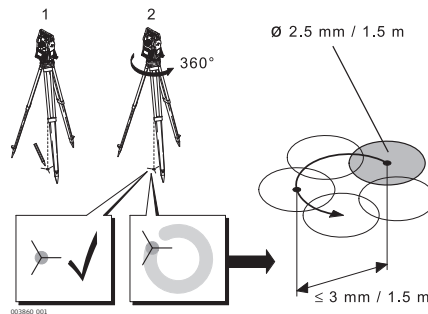

- 1 Set up the instrument on the tripod approximately 1.5 m above the ground and level up.
- 2 To activate the laser plummet, turn on the instrument, and, if tilt correction is set to 1- or 2-axis, the laser plummet will be activated automatically, and the **Level & Plummet** screen appears. Otherwise, press **FNC** from within any application and select **Level & Plummet**.



Inspection of the laser plummet should be carried out on a bright, smooth and horizontal surface, such as a sheet of paper.

- 3 Mark the center of the red laser dot on the ground.
- 4 Turn the instrument slowly through 360°, carefully observing the movement of the red laser dot.



The maximum diameter of the circular movement described by the center of the laser dot should not exceed 3 mm at a height of 1.5 m.

- 5 If the center of the laser dot makes a clearly circular movement, or moves more than 3 mm away from the point which was first marked, an adjustment may be required. Call your nearest GeoMax service department. Depending on brightness and surface type, the size of the laser dot can vary. At a height of 1.5 m an average diameter of 2.5 mm is estimated.

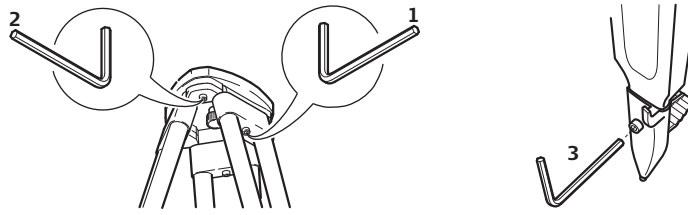
**Service the tripod
step-by-step**

 The connections between metal and timber components must always be firm and tight.

- 1) Tighten the leg cap screws moderately with the allen key supplied.
- 2) Tighten the articulated joints on the tripod head just enough to keep the tripod legs open when lifting the tripod off the ground.
- 3) Tighten the screws of the tripod legs.

13

Care and Transport

13.1

Transport

Transport in the field	When transporting the equipment in the field, always make sure that you <ul style="list-style-type: none">• either carry the product in its original transport container,• or carry the tripod with its legs splayed across your shoulder, keeping the attached product upright.
Transport in a road vehicle	Never carry the product loose in a road vehicle, as it can be affected by shock and vibration. Always carry the product in its transport container, original packaging or equivalent and secure it.
Shipping	When transporting the product by rail, air or sea, always use the complete original GeoMax packaging, transport container and cardboard box, or its equivalent, to protect against shock and vibration.
Shipping, transport of batteries	When transporting or shipping batteries, the person in charge of the product must ensure that the applicable national and international rules and regulations are observed. Before transportation or shipping, contact your local passenger or freight transport company.
Field adjustment	Periodically carry out test measurements and perform the field adjustments indicated in the User Manual, particularly after the product has been dropped, stored for long periods or transported.

13.2

Storage

Product	Respect the temperature limits when storing the equipment, particularly in summer if the equipment is inside a vehicle. Refer to "Technical Data" for information about temperature limits.
Field adjustment	After long periods of storage inspect the field adjustment parameters given in this user manual before using the product.
Li-Ion batteries	<ul style="list-style-type: none">• Refer to "Technical Data" for information about storage temperature range.• Remove batteries from the product and the charger before storing.• After storage recharge batteries before using.• Protect batteries from damp and wetness. Wet or damp batteries must be dried before storing or use.• A storage temperature range of 0°C to +30°C / +32°F to +86°F in a dry environment is recommended to minimize self-discharging of the battery.• At the recommended storage temperature range, batteries containing a 40% to 50% charge can be stored for up to one year. After this storage period the batteries must be recharged.

13.3

Cleaning and Drying

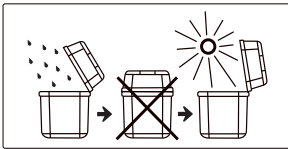
Objective, eyepiece and reflectors	<ul style="list-style-type: none">• Blow dust off lenses and prisms.• Never touch the glass with your fingers.• Use only a clean, soft, lint-free cloth for cleaning. If necessary, moisten the cloth with water or pure alcohol. Do not use other liquids; these may attack the polymer components.
Fogging of prisms	Prisms that are cooler than the ambient temperature tend to fog. It is not enough simply to wipe them. Keep them for some time inside your jacket or in the vehicle to allow them to adjust to the ambient temperature.
Damp products	Dry the product, the transport container, the foam inserts and the accessories at a temperature not greater than 40°C /104°F and clean them. Do not repack until everything is completely dry. Always close the transport container when using in the field. 
Cables and plugs	Keep plugs clean and dry. Blow away any dirt lodged in the plugs of the connecting cables.

14

Technical Data

14.1

Angle Measurement

Accuracy

Available angular accuracies	Standard deviation HA, VA, ISO 17123-3	Display resolution			
		["']	[°]	[mgon]	[mil]
2	0.2	1	0.0001	0.1	0.01
5	1.1	1	0.0001	0.1	0.01

Characteristics

Absolute, continuous, diametric.

14.2

Distance Measurement with Reflectors

Range

Reflector	Range A		Range B/C	
	[m]	[ft]	[m]	[ft]
Standard prism	1800	6000	3000	10000
Reflector foil 60 mm x 60 mm	150	500	250	800

Shortest measuring distance: 1.5 m

Atmospheric conditions

Range A: Strong haze, visibility 5 km; or strong sunlight, severe heat shimmer
Range B: Light haze, visibility about 20 km; or moderate sunlight, slight heat shimmer
Range C: Overcast, no haze, visibility about 40 km; no heat shimmer

Accuracy

Accuracy refers to measurements to standard reflectors.

EDM measuring mode	Standard deviation	Measurement time, typical [s]
P-Standard	2 mm + 2 ppm	2.4
P-Quick	3 mm + 2 ppm	2.0
P-Continuous	3 mm + 2 ppm	0.33
Foil	5 mm + 2 ppm	2.4

Beam interruptions, severe heat shimmer and moving objects within the beam path can result in deviations of the specified accuracy.

Characteristics

Absolute, continuous, diametric.

Range

Without reflector

Kodak Gray Card	Range D		Range E		Range F	
	[m]	[ft]	[m]	[ft]	[m]	[ft]
White side, 90 % reflective	150	490	180	590	≤280	≤919
Grey side, 18 % reflective	80	260	100	330	≤110	≤360

Range of Measurement: 280 m

Display unambiguous: 280 m

Atmospheric conditions

Range D: Object in strong sunlight, severe heat shimmer
 Range E: Object in shade, or overcast
 Range F: Underground, night and twilight

Accuracy

Standard measuring	Accuracy	Measure time, typical [s]	Measure time, maximum [s]
0 m - 280 m	3 mm + 2 ppm	3 - 6	15

Beam interruptions, severe heat shimmer and moving objects within the beam path can result in deviations of the specified accuracy.

Continuous measuring*	Standard deviation	Measure time, typical [s]
Continuous	5 mm + 3 ppm	1.0

* Accuracy and measure time depend on atmospheric conditions, target object and observation situation.

Characteristics

Type: Coaxial, visible red laser
 Carrier wave: 658 nm
 Measuring system: System analyser basis 100 MHz - 150 MHz

Laser dot size

Distance [m]	Laser dot size, approximately [mm]
at 50	12 x 24

14.4

Conformity to National Regulations

14.4.1

Zipp10 Pro

Conformity to national regulations



Hereby, GeoMax AG, declares that the instrument is in compliance with the essential requirements and other relevant provisions of applicable European Directives. The declaration of conformity is available from GeoMax AG.

14.5

General Technical Data of the Instrument

Telescope

Magnification:	30 x
Free Objective aperture:	40 mm
Focusing:	1.7 m/5.6 ft to infinity
Field of view:	1°30'/1.66 gon. 2.6 m at 100 m

Compensation

Quadruple axis compensation (2-axis compensator with HA-collimation and VA-Index).

Angular accuracy	Setting accuracy		Setting range	
[""]	[""]	[mgon]	[']	[gon]
2	0.5	0.2	±4	0.07
5	1.5	0.5	±4	0.07

Level

Tubular level sensitivity:	30"/2 mm
Electronic level resolution:	5"

Control unit

B&W display: 160 x 96 pixels, LCD, backlit, 6 lines with 20 characters each.

Instrument Ports

Name	Description
USB port	USB port for data transfer.
USB host port	USB memory stick port for data transfer.

Instrument Dimensions

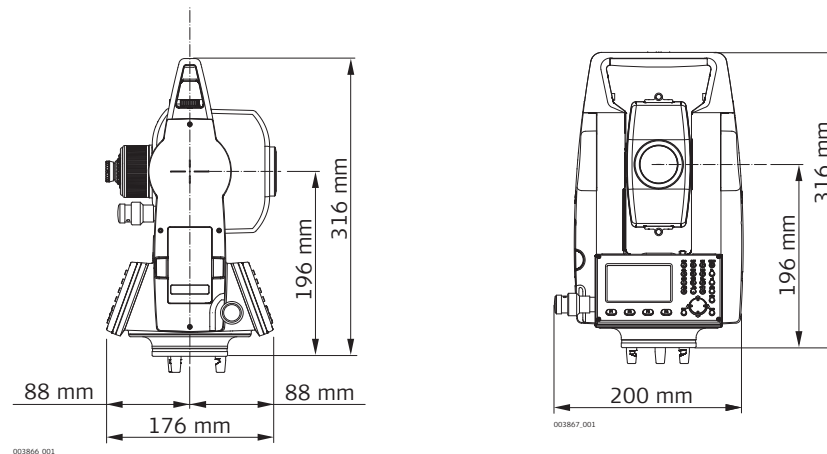

Weight

Instrument:	5.3 kg
Tribrach:	760 g
Battery ZBA301:	195 g

Tilting axis height

Without tribrach:	196 mm
With tribrach:	240 mm ±5 mm

Recording

Model	Memory Type	Number of measurements
Instrument	Internal memory	20,000

Laser plummet	Type:	Visible red laser class 2
	Location:	In standing axis of instrument
	Accuracy:	Deviation from plumb line: 1.5 mm (2 sigma) at 1.5 m instrument height
	Diameter of laser point:	2.5 mm at 1.5 m instrument height

Battery ZBA301	Type:	Li-Ion
	Voltage:	8.4 V
	Capacity:	4.4 Ah
	Operating time:	approximately 10 hours

Environmental specifications

Temperature

Type	Operating temperature		Storage temperature	
	[°C]	[°F]	[°C]	[°F]
Instrument	-20 to +50	-4 to +122	-40 to +70	-40 to +158
Battery	-20 to +50	-4 to +122	-40 to +70	-40 to +158

Protection against water, dust and sand

Type	Protection
Instrument	IP54 (IEC 60529)

Humidity

Type	Protection
Instrument	Max 95% non condensing. The effects of condensation are to be effectively counteracted by periodically drying out the instrument.

Automatic corrections

The following automatic corrections are made:

- Line of sight error
- Tilting axis error
- Earth curvature
- Standing axis tilt
- Vertical index error
- Refraction
- Compensator index error
- Circle eccentricity

14.6

Scale Correction

Use of scale correction By entering a scale correction, reductions proportional to distance can be taken into account.

- Atmospheric correction.
- Reduction to mean sea level.
- Projection distortion.

Atmospheric correction The slope distance displayed is correct if the scale correction in ppm, mm/km, which has been entered corresponds to the atmospheric conditions prevailing at the time of the measurement.

The atmospheric correction includes:

- Adjustments for air pressure
- Air temperature

For highest precision distance measurements, the atmospheric correction should be determined with:

- An accuracy of 1 ppm
- Air temperature to 1°C
- Air pressure to 3 mbar

Atmospheric corrections °C

Atmospheric corrections in ppm with temperature [°C], air pressure [mb] and height [m] at 60 % relative humidity.

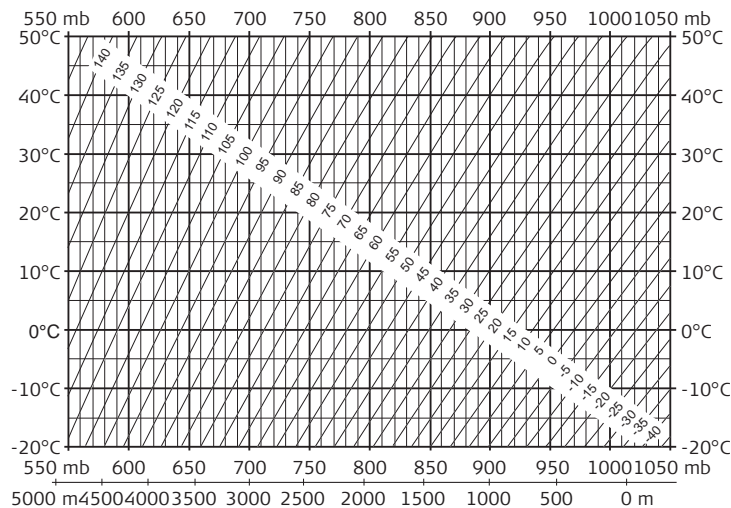

Atmospheric correction °F

Atmospheric corrections in ppm with temperature [°F], air pressure [inch Hg] and height [ft] at 60 % relative humidity.

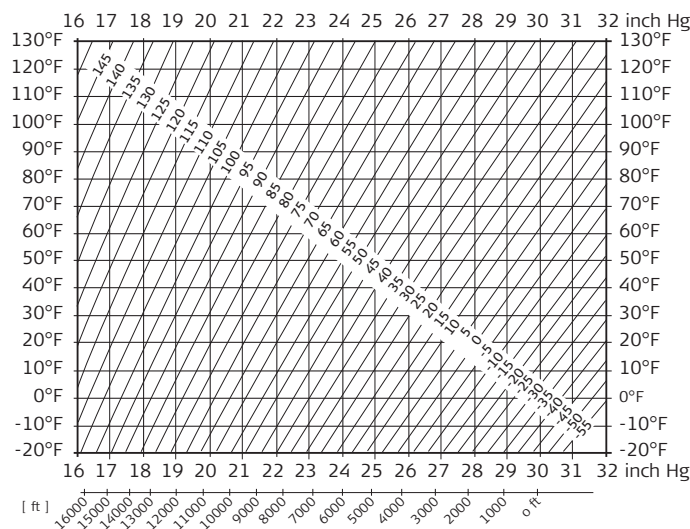

Formulas

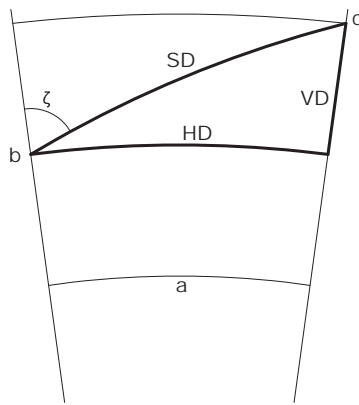

- a Mean Sea Level
- b Instrument
- c Reflector
- SD Slope distance
- HD Horizontal distance
- VD Height difference

The instrument calculates the slope distance, horizontal distance, and height difference in accordance with the following formulas. Earth curvature (1/R) and mean refraction coefficient (k = 0.13) are automatically taken into account when calculating the horizontal distance and height difference. The calculated horizontal distance relates to the station height and not to the reflector height.

Slope distance

$$SD = D_0 \cdot (1 + ppm \cdot 10^{-6}) + mm$$

- SD Displayed slope distance [m]
- D0 Uncorrected distance [m]
- ppm Atmospheric scale correction [mm/km]
- mm prism constant [mm]

Horizontal distance

$$HD = Y - A \cdot X \cdot Y$$

- HD Horizontal distance [m]
- Y $SD \cdot \sin\zeta$
- X $SD \cdot \cos\zeta$
- ζ = Vertical circle reading
- A $(1 - k/2)/R = 1.47 \cdot 10^{-7} [m^{-1}]$
- k = 0.13 (mean refraction coefficient)
- R = $6.378 \cdot 10^6$ m (radius of the earth)

Height difference

$$VD = X + B \cdot Y^2$$

- VD Height difference [m]
- Y $SD \cdot \sin\zeta$
- X $SD \cdot \cos\zeta$
- ζ = Vertical circle reading
- B $(1 - k)/2R = 6.83 \cdot 10^{-8} [m^{-1}]$
- k = 0.13 (mean refraction coefficient)
- R = $6.378 \cdot 10^6$ m (radius of the earth)

Software Licence Agreement

This product contains software that is preinstalled on the product, or that is supplied to you on a data carrier medium, or that can be downloaded by you online according to prior authorisation from GeoMax. Such software is protected by copyright and other laws and its use is defined and regulated by the GeoMax Software Licence Agreement, which covers aspects such as, but not limited to, Scope of the Licence, Warranty, Intellectual Property Rights, Limitation of Liability, Exclusion of other Assurances, Governing Law and Place of Jurisdiction. Please make sure, that at any time you fully comply with the terms and conditions of the GeoMax Software Licence Agreement.

Such agreement is provided together with all products and can also be referred to and downloaded at the GeoMax home page at <http://www.geomax-positioning.com> or collected from your GeoMax distributor.

You must not install or use the software unless you have read and accepted the terms and conditions of the GeoMax Software Licence Agreement. Installation or use of the software or any part thereof, is deemed to be an acceptance of all the terms and conditions of such Licence Agreement. If you do not agree to all or some of the terms of such Licence Agreement, you must not download, install or use the software and you must return the unused software together with its accompanying documentation and the purchase receipt to the distributor from whom you purchased the product within ten (10) days of purchase to obtain a full refund of the purchase price.

Instrument axis

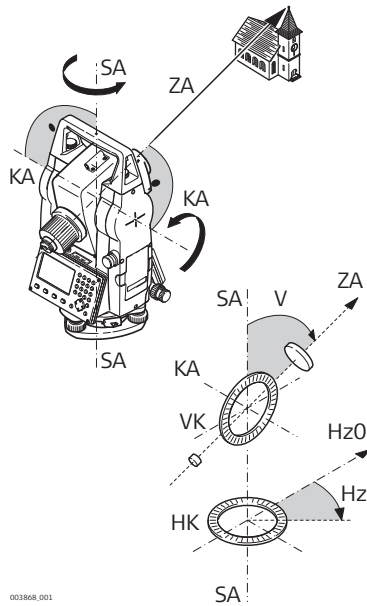

- ZA = Line of sight / collimation axis**
Telescope axis = line from the cross hairs to the center of the objective.
- SA = Standing axis**
Vertical rotation axis of the telescope.
- KA = Tilting axis**
Horizontal rotation axis of the telescope. Also known as the Trunion axis.
- V = Vertical angle / zenith angle**
- VK = Vertical circle**
With coded circular division for reading the vertical angle.
- Hz = Horizontal direction**
- HK = Horizontal circle**
With coded circular division for reading the horizontal angle.

Plumb line / compensator



Direction of gravity.
The compensator defines the plumb line within the instrument.

Standing axis inclination



Angle between plumb line and standing axis.
Standing axis tilt is not an instrument error and is not eliminated by measuring in both faces. Any possible influence it may have on the horizontal direction or vertical angle is eliminated by the dual axis compensator.

Zenith

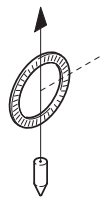

Point on the plumb line above the observer.

Crosshairs

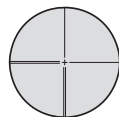

Glass plate within the telescope with reticle.

Line-of-sight error (horizontal collimation)

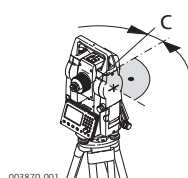

The line-of-sight error (c) is the deviation from the perpendicular between the tilting axis and line of sight. This could be eliminated by measuring in both faces.

Vertical index error

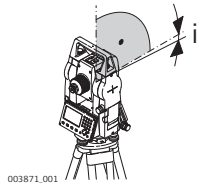

With a horizontal line of sight the vertical circle reading should be exactly 90° (100 gon). The deviation from this value is termed the Vertical index error (i).

Explanation of displayed data

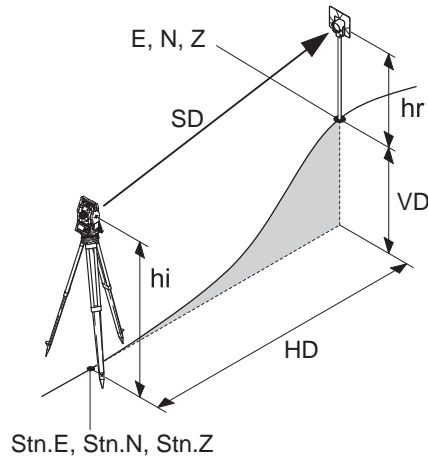

- SD Indicated meteorological corrected slope distance between instrument tilting axis and center of prism/laser dot
- HD Indicated meteorological corrected horizontal distance
- VD Height difference between station and target point
- hr Reflector height above ground
- hi Instrument height above ground
- Stn.E, Stn.N, Stn.Z
Easting, Northing and Height coordinates of station
- E, N, Z
Easting, Northing and Height coordinates of target point



Depending on local firmware versions the menu items may differ.

Menu Tree

- |--- **Quick-Survey**
- |--- **Data Collect**
- |--- **Set out**
- |--- **Apps**
 - |--- Missing Line
 - |--- Resection
 - |--- Area & Volume
 - |--- Remote Elevation
 - |--- Road Stakeout
- |--- **Data Manager**
 - |--- Jobs
 - |--- Known Points
 - |--- Observations
 - |--- Code Library
 - |--- Erase Memory
 - |--- Memory Info
- |--- **Setting**
 - |--- General
 - |--- Contrast, Tilt Correction, HA Correction, HA Increment, VA-Setting, Angle Unit, Minimum Reading, Distance Unit, Temperature Unit, Pressure Unit, Beep, Sector Beep, Display Illumination, Auto-OFF, Data confirmation, StartUp Display
 - |--- EDM
 - |--- EDM Setting, Atmospheric Data, Free Entry PPM, Projection Scale, EDM Signal Reflection, EDM Frequency
 - |--- System Info.
 - |--- Instrument Information, Software Information, Set Date, Set Time
- |--- **Calibration**
 - |--- HA-Collimatn
 - |--- Vert. Index
 - |--- View Calibration
- |--- **Data Transfer**
 - |--- Export
 - |--- Import
- |--- **Upload FW**
 - |--- Firmware

Appendix B Directory Structure

Description On the USB memory stick, files are stored in certain directories. The following diagram is the default directory structure.

Directory structure

— JOBS	• GSI
	• ASCII
— SYSTEM	• Firmware files

GeoMax Zipp10 Pro Series



813574-1.1.0en

Original text

© 2014 GeoMax AG, Widnau, Switzerland

GeoMax AG
www.geomax-positioning.com